

# Owner's Assembly and Operating Manual

## 15005LP, 15004P, 15003P



**15005LP**  
**Full Electric, Low Bed**



**15004P**  
**Semi-Electric Bed, Crank Hi/Lo**



**15003P**  
**Manual Bed, 3 Crank**

This manual must be given to the Owner/User of this bed and should be read carefully before putting this product into use. Keep manual in an accessible location for future reference.

# TABLE OF CONTENTS

<b>Standard Symbols &amp; Warning Labels</b> .....	1-3
<b>Intended Use &amp; General Safety</b> .....	4-6
<b>Electromagnetic Emmissions &amp; Immunity</b> .....	8
<b>Technical Specifications</b> .....	9-10
<b>Packaging and Handling</b> .....	11
Unpacking, Inspection, Storage.....	11
<b>Assembly Instructions</b> .....	12-14
<b>Frame Assembly</b> .....	15-19
<b>Bed Operation</b> .....	20-21
<b>Bed Rail Installation</b> .....	22-24
<b>Emergency (Power Outage) Manual Adjustment Crank</b> .....	25
<b>Maintenance &amp; Safety Checks</b> .....	26-27
<b>Warnings</b> .....	28-29
<b>Troubleshooting</b> .....	30
<b>Appendix: A Guide to Bed Safety Bed Rails</b> .....	31-32

**NOTE:** DO NOT operate this product without first reading and understanding this user manual. Damage or injury may result from improper use of this product.

Product features can change without notice.

# STANDARD SYMBOLS USED IN THIS MANUAL

This manual includes important information about the safety of personnel and equipment. As you read through this manual be aware of the symbols and their meanings.



Information that appears under the DANGER symbol concerns the protection of personnel from direct and pending hazards that, if not avoided, will result in immediate, serious personal injury or death in addition to damage of the equipment.



Information that appears under the DANGER SHOCK HAZARD symbol concerns the protection of personnel from possible hazards related to electrical shock.



Information that appears under the FIRE HAZARD symbol concerns the protection of personnel from possible hazards related to fire and flammability.



Information that appears under the WARNING symbol concerns the protection of personnel from possible hazards that can result in injury or death in addition to damage of the equipment.



Information that appears under the CAUTION symbol concerns the protection of personnel from possible hazards that may result in minor injury or damage of the equipment.





Information that appears under the CRUSH HAZARD symbol concerns the protection of personnel from possible hazards related to reduce clearances.





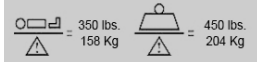

## NOTE:

Information that appears with the NOTE text gives added information, which helps in understanding the item being described.

## PRODUCT SYMBOLS

Symbols	Description	Symbols	Description
	Class II equipment		
	The owner's manual needs to be read before operating the bed.		Maximum patient weight and safe working load

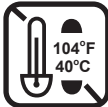
## PRODUCT HANDLING SYMBOLS

	Do not remove motor cover or repair yourself. Contact your local Provider or Dealer for technical assistance.
	Do not stack more than 5 cartons high
	Do not step
	Keep Dry
	Do not exceed 104 degrees F
	Do not leave in direct sun light for extended period of time
	Handle with care

# WARNING LABELS



**WARNING**

Incompatible ASSST RAILS can create hazards.  
READ INSTRUCTIONS FOR USE.



**WARNING**

Incompatible MATTRESSES can create hazards.  
READ INSTRUCTIONS FOR USE.





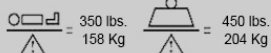

**WARNING**

Mattress must fit Bed Frame and Assist Rail snugly to help prevent patient entrapment. Patient entrapment with Assist Rail may cause injury or death. Please follow the manufacturer's instructions and monitor patient frequently. Please read and understand the Owner/Operator Manual prior to using this bed.

Product Name: Full Electric Bed  
Model: 15005LP  
Rated Input: 120V~, 60Hz, 3.15A max  
Duty Cycle : T\_ON 2min / T\_OFF 18min



  
  
  





Drive Devilbiss Healthcare  
99 Seaview Boulevard  
Port Washington, NY 11050

 **DANGER** Due to the risk of electric shock, do not attempt to open motor enclosure.

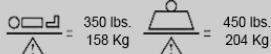
 **CAUTION** Please read the manual carefully before using this product.

Product Name: Semi-Electric Bed  
Model: 15004P  
Rated Input: 120V~, 60Hz, 3.15A max  
Duty Cycle : T\_ON 2min / T\_OFF 18min



  
  
  





Drive Devilbiss Healthcare  
99 Seaview Boulevard  
Port Washington, NY 11050

 **DANGER** Due to the risk of electric shock, do not attempt to open motor enclosure.

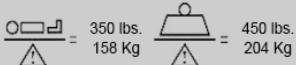
 **CAUTION** Please read the manual carefully before using this product.

Product Name: Manual Bed  
Model: 15003P



Drive Devilbiss Healthcare  
99 Seaview Boulevard  
Port Washington, NY 11050

 **CAUTION** Please read the manual carefully before using this product.

# INTENDED USE

The Drive #15005LP, 15004P, 15003P series beds are intended for use within a Homecare environment, Application Environment 4 (i.e.: care provided in a domestic area where ME Equipment is used to alleviate or compensate for an injury, disability or disease).

Beds are **NOT** intended for patient/resident transport. Wheels are provided only to allow movement within the patient/resident room for cleaning or patient/resident access.

## CONTRA-INDICATIONS

Electric beds should not be operated (control the movements of the bed through the control interfaces) by persons who do not have the cognitive skills to understand the information in the owner's manual or cannot understand and perform the proper operation of the bed. This bed should not be used or operated by children.

# GENERAL SAFETY

NOTE: In this manual, the terms patient and resident refer to a resident in a homecare environment.



## WARNING

- NEVER allow anyone under the bed at any time.
- DO NOT let any body parts protrude over the side or between parts, especially when the bed is being operated.
- Electric beds should not be placed in an oxygen enriched environment.
- Unplug electric beds or stop pressing pendant button when bed does not function as expected.
- DO NOT operate this product without first reading and understanding this user manual. Damage or injury may result from improper use of this product.
- Possible injury or Death may occur if accessories are not provided by Drive DeVilbiss Healthcare. Please contact Drive DeVilbiss Healthcare for accessories that are compatible with this bed.
- Possible injury or Death may occur if replacement parts are not provided by Drive DeVilbiss Healthcare. Please contact Drive DeVilbiss Healthcare for replacement parts compatible with this bed.



## WARNING

- Power cord on electric beds must be plugged into appropriate wall outlet, ensuring it can be unplugged easily in case of an emergency.
- Never permit more than one (1) person in/on the bed at any time. Never exceed the weight capacity of this bed. The weight capacity of this bed is **450lbs (205kg)** including accessories and options (not all accessories and options can be used at the same time). Once resident's weight is known (X), subtract that from 450 lb total weight capacity (Y) and remainder is allowable weight for mattress, accessories and optional equipment (Z). ( $Z = Y - X$ )

Assumes:	Max Patient/resident Weight	350 lbs (158.76 kg)
	Full or Half Rails (avg/pair)	25 lbs (11.34 kg)
	Mattress weight (avg)	25 lbs (11.34 kg)
	Trapeze	26 lbs (11.79 kg)

- The medical bed should be left in its lowest position except when care is being provided in order to reduce risk of injury due to falls.
- Electric beds **MUST** be connected to an appropriate power source. Mains cable and proper function must be checked regularly.
- Possible Injury or Death may occur if bed is pushed over abrupt thresholds while bed is occupied. **Beds are not intended for patient/resident transport.** Please use an approved resident transport device when moving a resident.



### **DANGER SHOCK HAZARD (15005LP & 15004P - Electric Beds Only)**

- DO NOT plug anything into the control box of bed (i.e. pendants and actuators) while mains cable (power cord) is plugged into the wall outlet.
- Any cords or tubing used on or with this bed MUST be routed and secured properly to ensure that they do NOT become entangled, kinked or severed during normal operation of the bed.
- DO NOT roll the bed over any power or pendant cords.
- DO NOT open any actuators, control boxes, or pendants. Service and repair must only to be performed by authorized service personnel. If unauthorized service is performed on any components the warranty is void.
- Inappropriate handling of power supply cords can create a shock hazard.
- When routing cables from other equipment in the medical bed, precautions shall be taken to avoid squeezing those between parts of the medical bed.
- DO NOT allow the cord, electrical outlets, and electrical control box or hand pendant to become wet or submerged.
- DO NOT operate the bed if any electrical component such as the power cord, electrical outlet, connections, motor/ actuator or mechanical component has malfunctioned or has been damaged in any way.
- The bed MUST be connected to an appropriate power source. Mains cable and proper function must be checked regularly.
- Possible injury or Death may occur due to pendant cord being a source for entangling patient/resident. Patients/ residents with decreased mental acuity should NOT have access to pendant.



### **FIRE HAZARD (15005LP & 15004P - Electric Beds Only)**

- DO NOT use near open flame or explosive gases.
- Possible Fire Hazard if used with nasal mask in 1/2 bed tent O2 administering equipment. If O2 tent is being used it should not fall below the mattress deck. The pendant should not be placed in an oxygen enriched environment such as an O2 tent.
- This bed should not be placed in an oxygen enriched environment.



### **CAUTION**

- These medical beds are not intended to work with patient lifts other than those specified by Drive DeVilbiss Healthcare as being compatible.
- Do NOT use side rails as handles for moving the bed.
- Keep all moving parts, including the mattress deck (sleep surface), main frame, all drive actuators and moving components free of obstructions.
- Ensure that the individual using this bed is properly positioned, particularly when the bed is being operated.
- Body weight should be evenly distributed over the sleeping surface of the bed. Avoid situations where entire body weight is on a raised head or foot surface. This includes while assisting the resident in repositioning or transferring in or out of bed.
- Supervision is required when this product is operated by or near children or people with disabilities.
- Do not modify this bed without authorization of the manufacturer. If unauthorized service is performed on any components the warranty is void.



### **CRUSH HAZARD**

- Possible crush hazard exists between the bed deck and frame. Keep hands and feet out from under the bed deck at all times while operating the bed.
- Possible Injury may occur when lowering or raising the bed. Keep feet and hands clear of bed frame.
- Do not put your hands/fingers into the opening of head or thigh deck edges, crush point may cause injury to your hands/fingers.



### **ENTRAPMENT WARNING**

- The entrapment issues can still arise when components and accessories are not properly installed.
- If a resident/patient's mental or physical condition could lead to resident/patient entrapment, the mattress deck (sleep surface) should be left in the flat position when unattended. Failure to do so could result in injury or death.
- Incompatible mattress and side rails can create hazards. Only compatible Drive DeVilbiss Healthcare side rails may be used on this bed. Make sure mattress is the correct size for bed frame and the Side rails are secured to frame to decrease the risk of entrapment.
- If bed frames have been serviced or any other adjustments have been made, you must ensure all parts are securely back in place before operating the bed.



### **WARNING**

Incompatible mattress and side bars/rails can create hazards. Read instructions for use.

## **MATTRESS SPECIFICATIONS**



### **WARNING**

Possible ENTRAPMENT Hazard may occur if you do not use the recommended specification mattress.

Resident entrapment may occur leading to injury or death.

- A mattress may not be included with this bed. It is recommended that a standard 36" wide mattress that is made to fit an 80" or 84" (extension) length bed frame is used, such as a Drive DeVilbiss Healthcare standard inner spring, foam, fiber, or pressure redistribution mattress. Mattress height must be a minimum of 5-1/2 inches and a maximum of 7 inches.
- Also available are Drive DeVilbiss Healthcare's assortment of mattress overlays and Low Air Loss flotation mattress systems.



# ELECTROMAGNETIC EMISSION AND IMMUNITY

This MEDICAL ELECTRICAL EQUIPMENT needs special precautions regarding EMC and needs to be installed and put into service according to the EMC information provided in the table below.

Portable and mobile RF communications equipment can affect MEDICAL ELECTRICAL EQUIPMENT



## WARNING

The use of ACCESSORIES, transducers and cables other than those specified, with the exception of transducers and cables sold by the manufacturer of the EQUIPMENT or SYSTEM as replacement parts for internal components, may result in increased EMISSION or decreased IMMUNITY of the EQUIPMENT or SYSTEM.

Below cables information are provided for EMC reference

Cable	Max. cable length, Shielded/unshielded		Number	Cable classification
AC Power Line	3.8m	Unshielded	1 Set	AC Power



## WARNING

### Important information regarding Electro Magnetic Compatibility (EMC)

FULL ELECTRIC & SEMI ELECTRIC BEDS require special precautions regarding EMC when put into service according to the EMC information provided in the user manual and special precautions need to be observed:

FULL ELECTRIC & SEMI ELECTRIC BEDS with no ESSENTIAL PERFORMANCE is intended for use in a professional healthcare facility environment and homecare environment.

WARNING: Portable RF communications equipment (including peripherals such as antenna cables and external antennas) should be used no closer than 30 cm (12 inches) to any part of the SEMI ELECTRIC BED WITH MANUAL LEG ADJUST, including cables specified by the manufacturer. Otherwise, degradation of the performance of this equipment could result.

The use of accessories and cables other than those specified by Drive DeVilbiss Healthcare, with the exception of accessories and cables sold by Drive DeVilbiss Healthcare for use with the FULL ELECTRIC & SEMI ELECTRIC BEDS as replacement parts for internal components, may result in increased EMISSIONS or decreased IMMUNITY.

WARNING: Use of this FULL ELECTRIC & SEMI ELECTRIC BEDS adjacent to or stacked with other equipment should be avoided because it could result in improper operation.



## ELECTRICAL SAFETY WARNINGS

A safety feature of this product includes protection against overheating caused by excessive or extended periods of operation. Depending on the duration, this includes multiple or repeated adjustments or the use of multiple functions at one time. To ensure trouble free operation, always allow a slight pause between multiple adjustments and avoid pressing more than one function button at a time. If thermal protection activation should occur, the bed will not respond to pendant commands. Given this situation, release the pendant button and allow the bed unit to sit for several minutes. This will allow the protection function time to reset and restore bed function. Depending on severity of the initial overheating, this could take up to 30 minutes.

Allow a slight pause between adjustments and avoid pressing multiple buttons at the same time. If pendant buttons are depressed too rapidly or multiple buttons are pressed at the same time, the desired feature may not activate. Simply release the pendant button, permit a slight pause and then activate the next operation.

Always unplug the bed from the electrical outlet before cleaning.

DO NOT open assemblies such as the motors, motor housing or pendant. No user serviceable parts are inside. Only qualified technicians are permitted to repair these parts. If unqualified individuals perform any work on these beds, the warranty is void.

DO NOT place pendant under or between objects. This may unintentionally press the buttons and may cause injury or damage.

Electronic equipment may be influenced by Radio Frequency Interference (RFI). Caution should be exercised with regard to the use of portable communications equipment in the area around such equipment. If RFI causes erratic behavior, unplug the electric bed IMMEDIATELY. Leave unplugged while transmission is in progress.

Ensure all cables and cords are routed such that they will not become entangled or pinched. Otherwise damage or injury may result.

If a button on the pendant sticks or does not release and/or one of the functions will not stop moving. Unplug the power cord from the electrical supply outlet and take the bed out of service for repair.

If a liquid is spilled in or around the electric bed, unplug the electric bed before cleaning. Clean up the spill and allow the electric bed or the area around the electric bed to dry thoroughly before using the electric controls again.

Inspect the covering of the hand pendant panel to assure that the covering is not cracked or damaged.

Keep all electrical cords away from heated or hot surfaces.

Keep the cord away from heated surfaces.

NEVER operate this bed if it has a damaged cord or plug, if it is not working properly, if it has been dropped, damaged, or dropped into water. Return the bed to a service center for examination and repair.

On Full & Semi Electric beds, the Hi/Lo crank MUST be removed before the bed is used. Failure to remove the crank may cause damage or personal injury.

Refer servicing to qualified personnel only. Grounding reliability depends upon a properly grounded wall outlet.

The pendant and power cords must be routed and secured properly to ensure that the cords DO NOT become entangled, pinched and/or severed during operation of the electric bed.

Unplug from the outlet before servicing. Unplug the power cord from its power source before performing any maintenance on the manual/electric bed.

Use caution when disconnecting the pendant. DO NOT press pendant buttons.

When bed is not to be used for an extended period, unplug electric bed from the wall outlet.

When using an extension cord, use an extension cord having at least 16 AWG (American Wire Gauge) wire and the same or higher electrical rating as the device being connected. Use of improper extension cord could result in a risk of fire and electric shock.

When using nasal or masked type oxygen administering equipment, the oxygen or air tubing MUST be routed and secured properly to ensure that the tubing does not become entangled and/or severed during normal operation of the bed.

DO NOT use Full & Semi Electric beds near explosive gases.

Possible fire hazard when used with oxygen administering equipment other than nasal or masked type.

Use masked or nasal type oxygen administering equipment only in conjunction with this bed. The use of ANY other type of oxygen administering equipment can result in a fire hazard.

# TECHNICAL SPECIFICATIONS

	15005LP	15004P	15003P
Overall Length	87.99"	87.99"	87.99"
Overall Width w/o Rails	36.22"	36.22"	36.22"
Overall Width w/Rails	38.58"	38.58"	38.58"
Length & Width of Mattress Deck	79.53" x 34.65"	79.53" x 34.65"	79.53" x 34.65"
Maximum Weight Capacity	350 lbs Patient Wgt/ 450lbs. includes all accessories	350 lbs Patient Wgt/ 450lbs. includes all accessories	350 lbs Patient Wgt/ 450lbs. includes all accessories
Head Deck Angle	0°to 70°	0°to 70°	0°to 70°
Foot Deck Angle	0°to 46°	0°to 46°	0°to 46°
Height Range	9.5" - 22.5"	14.96" - 22.83"	14.96" - 22.83"
Under Bed Clearance	2.6"	5.9"	5.9"
Total Product Weight (lbs.)	169	161	156
Head End & Head Section	68	67	67
Foot End & Foot Section	101	94	89
Noise Level	≤65dB(A)	≤65dB(A)	N/A
Electrical Requirements	120VAC,60Hz	120VAC,60Hz	N/A
Rated Current Input	3.15A max	3.15A max	N/A
Fuse Specification	2A 250V	2A 250V	N/A
Duty Cycle	T_On 2 Min / T_Off 18 Min	T_On 2 Min / T_Off 18 Min	N/A
Battery Backup	N/A	N/A	N/A
Relative Humidity	15% to 93% relative humidity, non-condensing	15% to 93% relative humidity, non-condensing	15% to 93% relative humidity, non-condensing
Recommended Storage &Shipping Temperature	-22°F to +158°F	-22°F to +158°F	-22°F to +158°F
Recommended Operating Temperature	41°F to 104°F	41°F to 104°F	41°F to 104°F
Atmospheric Pressure Range	700hPa to 1060hPa	700hPa to 1060hPa	700hPa to 1060hPa

Component Item #	Description	Shipping Weight (lbs)	Length (inch)	Width (inch)	Height (inch)
<b>15005LP</b>					
15215P	Headspring&Low Headboard F/15005LP 1/cv	74.8	44.1	8.1	37.4
15216P	Footspring&Low Footboard F/15005LP 1/cv	101	47.4	10.2	37.4
<b>15004P</b>					
15210P	Headspring&Headboard,for 15004P & 15003P 1/cv	73.8	44.1	8.1	37.4
15212-LP	Footspring&Footboard For 15004P,1/cv	102.3	47.4	10.2	37.4
<b>15003P</b>					
15210P	Headspring&Headboard,for 15004P & 15003P 1/cv	73.8	44.1	8.1	37.4
15211P	Footspring&Footboard, for 15003P 1/cv	96.9	47.4	10.2	37.4

# PACKAGING / HANDLING

## OPERATING TEMPERATURE

If bed has been stored in an area where the temperature is above or below the Recommended Operating Temperature range of 41°F to 104°F. You must wait at least 30 minutes for the bed temperature to adjust to the Recommended Operating Temperature range of 41°F to 104°F before use.

## BED SERIAL NUMBERS

When ordering parts or when contacting Drive DeVilbiss Healthcare Customer Service Department, please include bed's model and serial numbers, found on the identification labels as below. The identification labels are located under the sleep deck on the either side of the bed frame.

## COMPLIANCE INFORMATION

Matching the correct bed components to meet regulatory specifications can be complicated. Drive DeVilbiss Healthcare offers a wide variety of compliance options and we can assist your facility in selecting components or accessories that are recommended for the specific bed model.

## TOOLS REQUIRED

- Wire Cutters
- Utility Knife



### CAUTION

Unpack the bed in an area with sufficient room to work. Do not allow residents/patients near the bed until it has been completely set up and the work area has been cleared of all debris.

## UNPACKING

1. Check cartons for any obvious damage to packaging or contents. If damage is evident, contact your local Drive Medical dealer/provider.
2. Remove any loose packaging from the cartons.
3. Carefully remove all components from the cartons.

## Packaging

The Two Cartons will contain the following components:

### 15005LP

#15215P HeadSpring and Head Board w/casters

#15216P Foot Spring and Foot Board w/ junction box, 3 motor/actuators, Hand Pendant Control, Emergency Crank Handle.

### 15004P

#15210P HeadSpring and Head Board w/casters for 15004P & 15003P

#15212-LP Foot Spring and Foot Board w/ junction box for 15004P, 2 motor/actuators, Hand Pendant Control.

### 15003P

#15210P HeadSpring and Head Board w/casters for 15004P & 15003P

#15211P Foot Spring and Foot Board, manual 3 crank for 15003P

## **INSPECTION**

1. Examine each component carefully for damage, scratches, dents or any other visual damage.
2. Carefully remove Tie Wraps holding power cord, hand pendant and drive shaft.
3. Inspect power cord and plug for cuts or damage.
4. Inspect the motors for damage, loose connections, cuts or damage to the wires.
5. Ensure motor connection to junction box and pendant are connected correctly and secure.

## **STORAGE**

1. If the bed is not assembled immediately, retain cartons and packaging for storage until assembly is completed.
2. Store the packaged bed in a dry area.
3. DO NOT place other objects on top of the packaged bed cartons.

# ASSEMBLY

1 Confirm that all parts are present:

## 15005LP

A. Foot Spring w/

- 3 motor/actuators
- Junction Box
- Hand Pendant
- Power cord & plug

B. Head Spring

C. Low Height Head Board

D. Low Height Foot Board

E. Hi/Low Drive Shaft

F. Locking Pins (2)

G. Emergency Manual Hand Crank

H. Casters (4) – 2 locking, 2 non-locking

I. Head/Foot Pull Tube Transport Straps

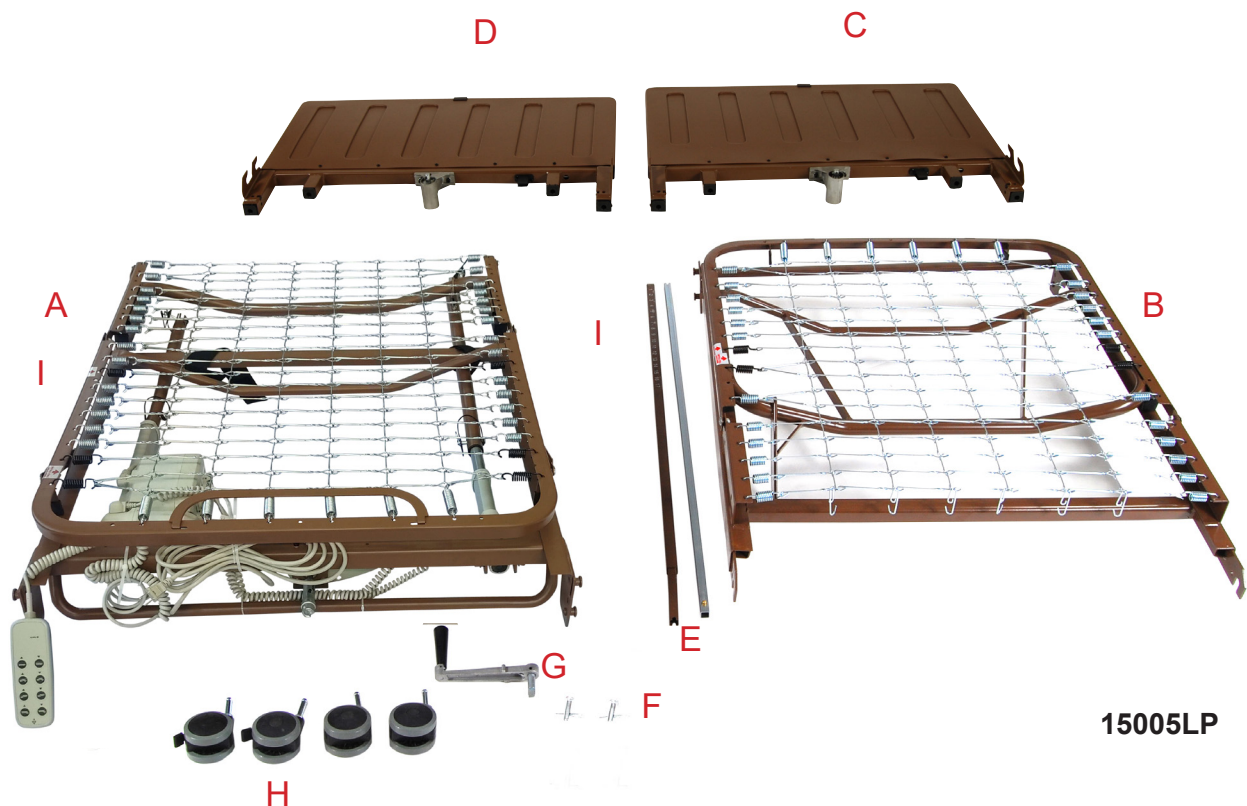

**Caution:** DO NOT attempt to operate bed controls until completion of assembly as damage to bed components and/or personal injury may occur.

# ASSEMBLY

1 Confirm that all parts are present:

## 15004P

A. Foot Spring w/

- 2 motor/actuators
- Junction Box
- Hand Pendant
- Power cord & plug

B. Head Spring

C. Standard Height Head Board

D. Standard Height Foot Board

E. Hi/Low Drive Shaft

F. Locking Pins (2)

G. Hand Crank

H. Casters (4) – 2 locking, 2 non-locking

I. Head/Foot Pull Tube Transport Straps

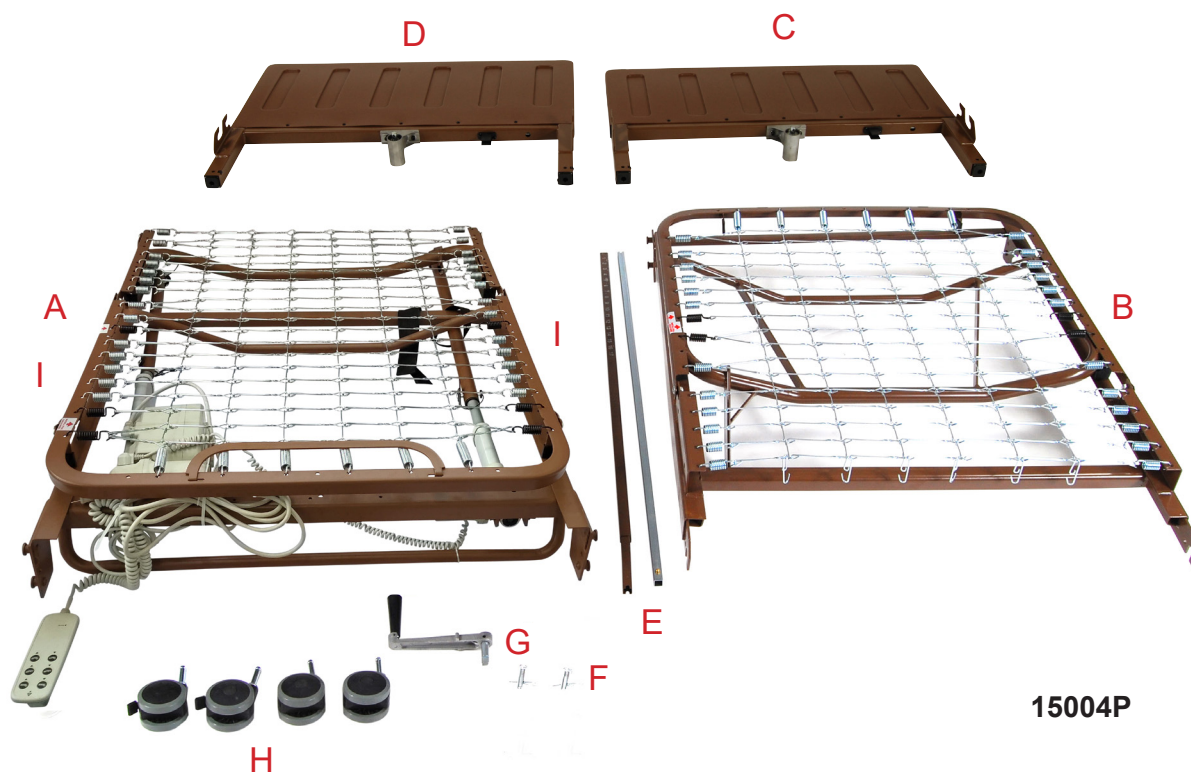



# ASSEMBLY

1 Confirm that all parts are present:

## 15003P

- A. Foot Spring w/
  - 2 Manual Cranks
- B. Head Spring
- C. Low Height Head Board
- D. Low Height Foot Board
- E. Hi/Low Drive Shaft
- F. Locking Pins (2)
- G. Hand Crank
- H. Casters (4) – 2 locking, 2 non-locking
- I. Head/Foot Pull Tube Transport Straps

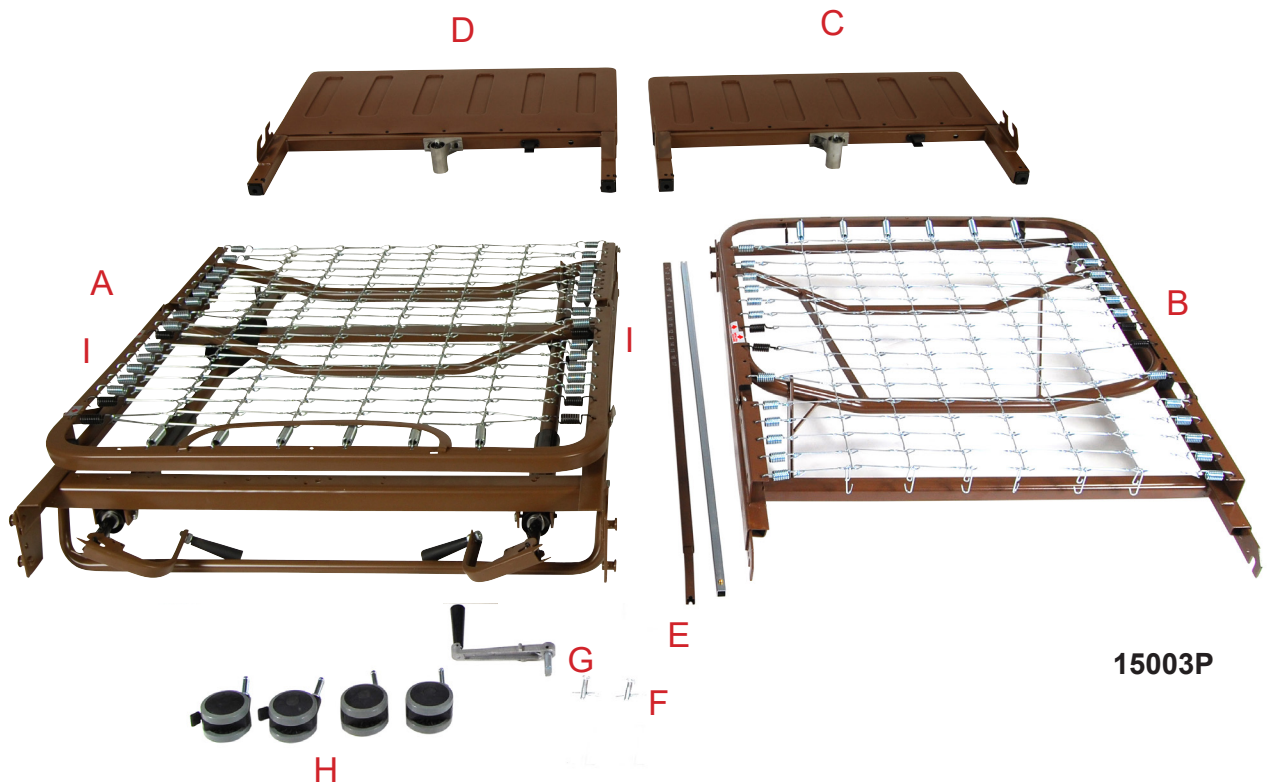



# ASSEMBLY

## 2. Connecting the Spring Sections: Full Electric; Semi Electric; Manual

- A. Remove the Head Spring from carton and place on its side to your right with the center mounting latches to your left.
- B. Remove the Foot Spring from carton and place on its side to your left with the foot spring mounting latches to your right.
- C. The Head and Foot Springs should now be positioned upright on their sides at approximately a 90-degree angle to one another.
- D. Connect the Head Spring to the Foot Spring by aligning the mounting latches and swinging both ends away from each other so both springs are now hooked and aligned in a straight/horizontal position.

NOTE: It may be necessary to lift the Head and/or Foot Spring slightly to align and engage the mounting latches to the mounting pins.

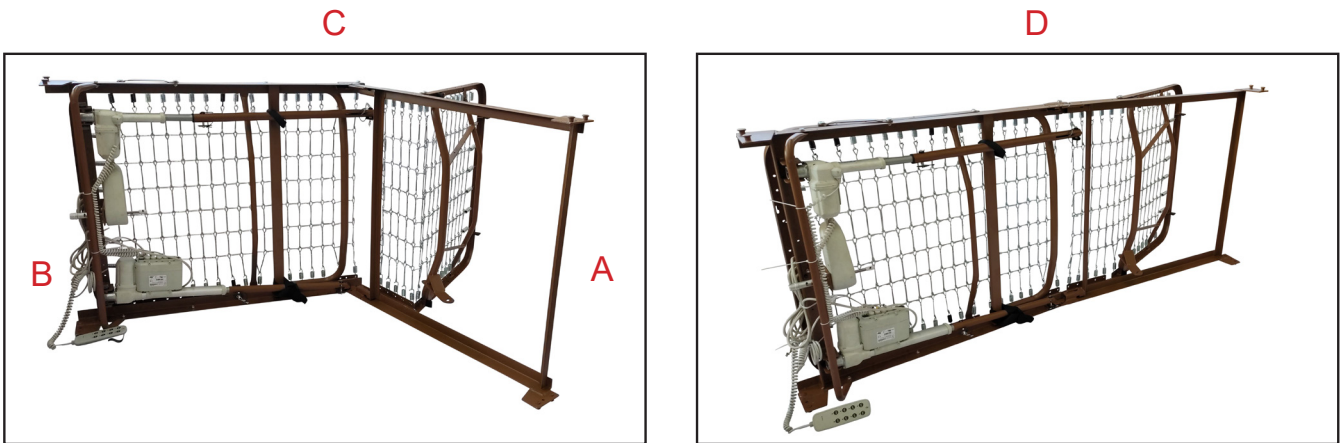

Note: 15005LP shown for illustrative purposes only for assembly

- 3. Optional: Insert lock pin through connected sleep surface and secure with spring clip.



# ASSEMBLY

4. Connect Head Spring and Foot Spring Pull Tube to provide the up/down motion/adjustment of the Head and Foot Spring Sections:
  - A. Extend the Head Spring Pull Tube and connect to the Head Spring Lift Arm. Secure in place with the tethered locking pin and clip
  - B. Extend the Foot Spring Pull Tube and connect to the Foot Spring Lift Arm. Secure in place with the tethered locking pin and clip

NOTE: Extend the inner pull tube until the spring button “clicks” into the adjustment hole of the outer tube. The spring button should protrude through the adjustment hole and the clevis pin of the now extended pull tube arm will line up with the lift arm slot.

If the Head or Foot Spring fail to elevate once assembled, check that the spring button is properly aligned and locked into the adjustment hole (C).

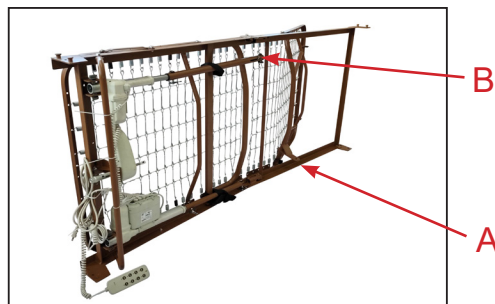
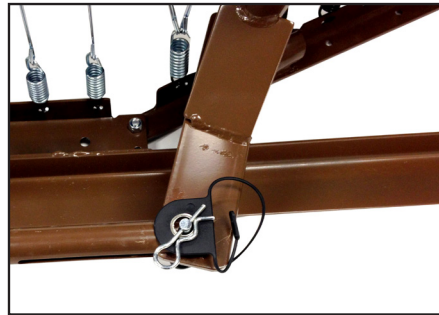

C pull tube spring button

# ASSEMBLY

5. Install the casters by inserting the stem of the caster into the leg receptacle. It is recommended to install one locking caster and one non-locking caster on each bed end. The locking casters should be installed diagonally from each other.

The 15005LP Low Height bed gives you the option of installing the casters on the inboard non adjustable legs or the outboard adjustable legs. To achieve the full low height feature, install the casters on the inboard non-adjustable legs.

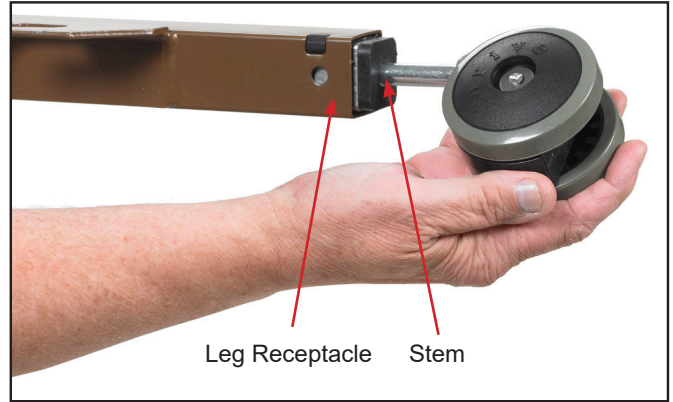

6. Install bed ends:

- A. Carefully lower the bed frame flat onto the floor. Attach the Head and Foot Boards by tilting the Boards toward your body and aligning mounting pins located on the Spring Sections with the Hooks on the Head/Foot Boards.
- B. Stand the Head Board as close to the Head Spring as possible.
- C. With one hand, grasp the Head Spring Frame and raise it until the frame connecting pins are at the correct height to fit into the Bed End Hooks.
- D. Tilt the Head Board backward slightly and the pins should slide into the hooks.
- E. When the Head Board is returned to its full upright position, the Head Board will lock into place.
- F. Repeat the same procedure for the Foot End Section.

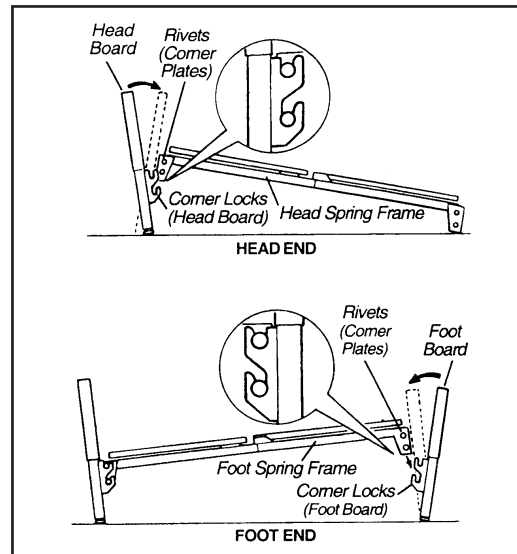

NOTE: The Head Board is taller than the Foot Board, however, they are interchangeable with each other. Head and foot boards are embossed on the top.

# ASSEMBLY

7. Assemble Hi/Lo Drive Shaft and adjust to the proper length so it will fit between the Head Board drive pin and Hi/Lo Motor drive pin or foot board gear box at the foot end.
- A. The Hi/Lo Drive Shaft comes in 2 sections. Assemble the Hi/Lo Drive Shaft by inserting the (A) section with push pin into the (B) section with indicators and align with the Full; Semi or Manual indicator hole.

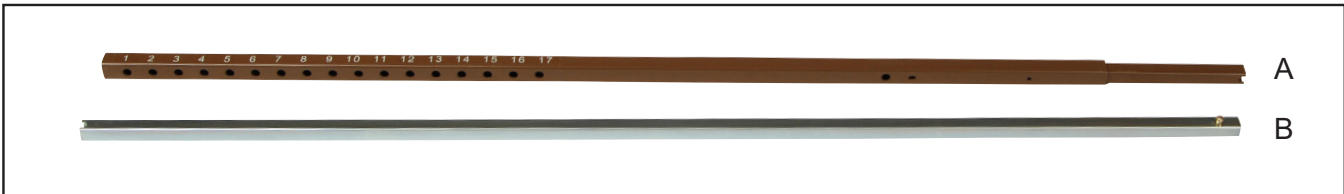

- B. Install the Hi/Lo Driveshaft to the bed

#15005LP: Lift the Head Spring and install the foot end of the Hi/Lo Drive Shaft to the Hi/Lo Motor drive pin, then install head end of the Hi/Lo Drive Shaft to the Head Board drive pin.

- Release the spring loaded shaft on the hi/low motor and insert the shaft into the gear box on the footboard.

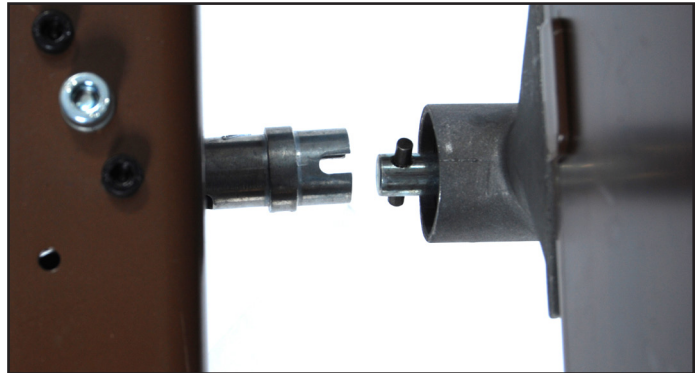

- Make sure the slot on the spring loaded shaft engages the roll pin on the gear box.

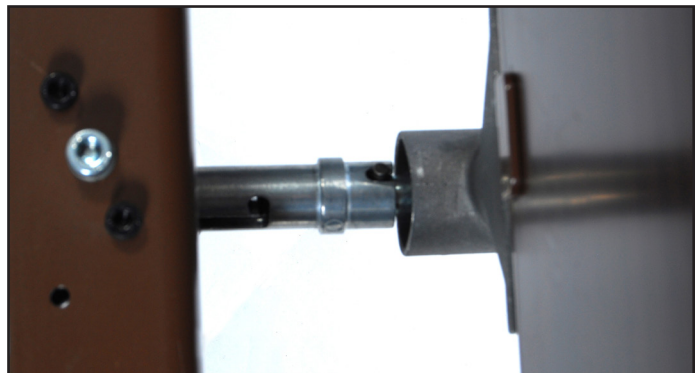



## ASSEMBLY

#15004P & 15003P: Lift the Head Spring and install the foot end of the Hi/Lo Drive Shaft to the Foot Board drive pin, then install head end of the Hi/Lo Drive Shaft to the Head Board drive pin.

Hi/Lo Drive Shaft is spring loaded so it will fit securely between these two points.

Adjust length of Hi/Lo Drive Shaft if it is too long or too short.



8. Raise the Head Spring and Foot Spring to release tension between the springs and connect Head and Foot spring fabric by squeezing together and attaching with spring links.



# OPERATION

## Hand Pendant Control

15005LP Pendant



15004P Pendant



15003P Hand Cranks

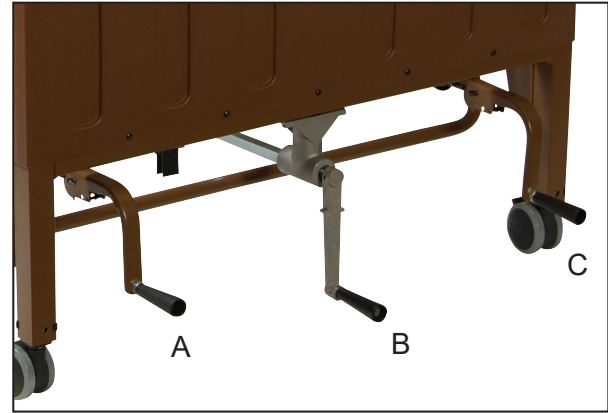

### Model #15005P

- First row buttons control raising and lowering the Head Section.
- Second Row buttons control raising and lowering the Foot Section.
- Third row buttons simultaneously control the raising and lowering of the Head and Foot Sections.
- Fourth row buttons raise and lower the height of the bed.
- There are two LED indicators on the hand pendant panel. One indicates the power is on, the other indicates the key function is working.

### Model #15004P

- First row buttons control raising and lowering the Head Section.
- Second Row buttons control raising and lowering the Foot Section.
- Third row buttons simultaneously control the raising and lowering of the Head and Foot Sections.
- There are two LED indicators on the hand pendant panel. One indicates the power is on, the other indicates the key function is working.

NOTE: Operate the bed through all phases of its operation. If any problems arise during the test, recheck all electrical connections and mechanical hook ups. Full and Semi Electric beds come with an emergency crank to allow continued operation in the event of a power outage.

### Model #15003P 3 Crank Manual Bed Operation

Looking at the Foot End of the Bed and going from left to right:

- Crank (A) controls raising and lowering the Head Section;
- Crank (B) controls raising and lowering the entire bed;
- Crank (C) controls raising and lowering the Foot Section;

Turn Manual Cranks clockwise to raise that section of the bed and counter clockwise to lower that section of the bed.

# OPERATION

## 15005LP

### Low Height Caster Position

#### Caster Lock and Floor Lock Feature

When the bed is in its lowest height position, the Casters will come in contact with the floor and the bed will roll freely. Engaging the Caster Locks will help hold the bed in place.

When the bed height is raised, the legs will come in contact with the floor and the casters will be raised off the floor providing a stable base for the bed frame.

Hi Position

Lo Position



## BED OPERATION



### CRUSH HAZARD

Crush point exists due to LOW BED CLEARANCE. Do NOT place feet or other limbs under the frame when lowering the bed. When lowering the bed, be aware this may cause INJURY if limbs or personal items interfere with bed movement. Stay clear of the frame and ensure children and/or pets are not under the bed before lowering.

### WARNING

- It is critically important to lock all casters to prevent unintended bed movement.
- Possible injury or Death may occur due to pendant cord being a source for entangling patient/resident. Patients/residents with decreased mental acuity should NOT have access to pendant.



### WARNING

When routing cables from other equipment in the medical bed, precautions shall be taken to avoid squeezing between parts of the medical bed.

# SIDE RAIL INSTALLATION (OPTION)



## SIDE RAIL WARNING

Other manufacturers side rails/bars may not be compatible and can lead to entrapment issues or harm to patients/residents. Only compatible side rails/bars may be used on this bed. Make sure bed frame is adjusted correctly for mattress size being used and side rails/bars are properly secured to frame to decrease the risk of entrapment.



## ENTRAPMENT WARNING

The risks associated with these devices used in conjunction with specialty mattresses and mattress overlays have not been evaluated. When these specialty mattresses or mattress overlays are used, the end user facility must take steps to ensure that the therapeutic benefit outweighs the risk of entrapment.



## SIDE RAIL WARNING

Side rails/bars serve as a passive reminder to help keep patient from falling out of the bed.



## CRUSH HAZARD

Crush hazard exists between the side rails/bars and the floor when in the lowest position which may cause injury to oneself or others. Do NOT place feet beneath the side rails/bars.



## SIDE RAIL WARNING

Although side rails are not rated to any specific weight limitation, the side rails may become deformed or broken if excessive side pressure is exerted on the bed rails. The side rail is not an assist device for getting into or out of bed.

DO NOT use the side rails as push handles when moving the bed. Always test to make sure that the side rails are properly and securely in place before using the bed.

DO NOT install the optional side rails without reading and understanding all of the instructions in the instruction sheet that accompanies the bed rail kit.

DO NOT use the side rails as push handles for moving the bed.

Side rails are intended to prevent an individual from inadvertently rolling out of bed. DO NOT use for restraint purposes.

When used with a manual/electrical bed, side rails DO NOT fall under any weight limitations. Side rails can be deformed or broken if excessive side pressure is exerted on the bed rails. Side rails are used for the purpose of preventing an individual from inadvertently rolling out of bed. Side rails are NOT intended nor may be used for restraint purposes. If an individual is capable of injuring himself/herself, a physician or a healthcare professional should be consulted for alternative means of safe restraint.



## ENTRAPMENT WARNING

Accurate assessment of the patient/resident and monitoring of correct maintenance and equipment use are required to prevent entrapment. For additional information on product and safety issues for bed frames and rails refer to product manuals specific to the product or accessories you have or are planning to install. If bed frames have been serviced or any other adjustments have been made, you must ensure all parts are securely back in place before operating the bed. Other manufacturers side rails may not be compatible and can lead to entrapment issues or harm to residents and staff. Make sure mattress is the correct size for bed frame and the Side rails are secured to frame to decrease the risk of entrapment.

On March 10, 2006, the U.S. Food and Drug Administration (FDA) released guidelines for reducing the risk of hospital bed entrapment entitled; "Hospital bed System Dimensional and Assessment Guidance to Reduce Entrapment". This guidance document identifies potential entrapment areas within the bed frame, rails and mattress and identifies those body parts most at risk for entrapment. It also provides manufacturers with basic design criteria to consider when



developing hospital/convalescent beds; recommends specific test methods to assess the conformance of existing hospital/convalescent bed systems; and answers frequently-asked questions about entrapment issues.

The FDA Guidance document identifies specific dimensional criteria on potentially injury-threatening gaps and spaces that can occur between bed system components, such as side rails when improperly installed.

Please be aware that entrapment issues can still arise when components and accessories are not properly installed on the bed. It is important for the provider or facility staff to recognize they have an equal role in complying with the FDA guidelines to help ensure resident safety and avoid injuries.

Copies of this document can be obtained from the FDA website:

<http://www.fda.gov/medicaldevices/deviceregulationandguidance/guidancedocuments/ucm072662.htm>

## BED RAIL INSTALLATION (OPTIONAL)

The Deck Frame contains labels that provide the location for installing Half Rails and Full Rails.

- On the Head Section and Foot Sections, a Label will indicate the notch location for alignment of the Full Rail Cross Brace that must be positioned in between the two black springs. A second Label will indicate alignment for the Half Rail clamp to be positioned with the Black Spring centered between the clamp.

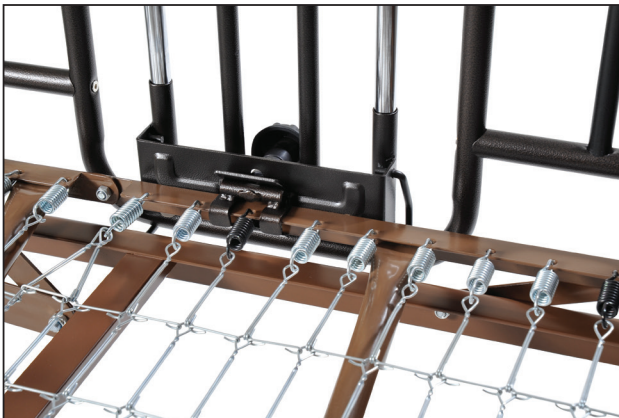

Half Rails



Full Rails

## MATTRESS RETAINER ADJUSTMENT

Before a mattress is laid on the bed, flip up the mattress guard to reduce the movement of the mattress.

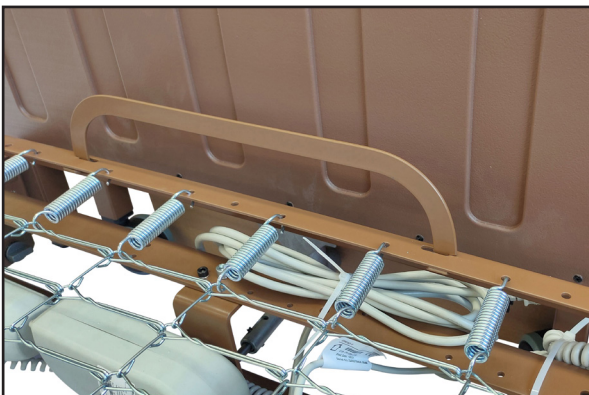

# MANUAL ADJUSTMENT CRANK

## Emergency Crank Manual Adjustment (Power Outage)

### Using the Emergency Crank

Use the emergency crank to make the adjustments if the Full Electric (15005LP) or Semi-electric (15004P) bed needs to be adjusted manually due to a power outage or an electronic malfunction.

The Emergency crank is usually stored in the link fabric of the bed deck. If you do not find the emergency crank, contact your provider.

**WARNING:** Emergency Manual Adjustment Crank **MUST BE REMOVED** before the 15005LP bed is used. Failure to remove the crank may cause damage to the bed and/or personal injury to those in the room.

1. Remove the emergency crank from the bed deck under the mattress.
2. From the Foot Board end of the bed, locate the exposed shaft connection of the motor according to the function you want to perform.
3. Attach the emergency crank to A (Head Section motor), B (Hi/Lo Motor), or C (Foot Section Motor) connection point.

NOTE: The 15005LP Hi/Lo Hand Crank can be operated in two locations: directly into the Head or Foot board gear box or from the top of the Foot Board access port.

4. To raise and lower the entire bed on 15005LP full electric models in the low height position, open cover on the top of the foot board and insert crank.

NOTE: Push in the emergency crank while turning in the desired clockwise or counter clockwise direction.

**WARNING:** Manual Emergency Adjustment Cranks **MUST BE REMOVED** before the bed is used. Failure to remove the crank may cause damage to the bed and/or personal injury to those in the room.



# MAINTENANCE & SAFETY CHECKS

Drive recommends the following maintenance and cleaning procedures be conducted between users.

## ELECTRONICS

- Check all controls to make sure all functions work properly.
  - Foot control
  - Head control
  - Hi/Lo
- Check all cables for damaged or frayed wires.
  - Power cord
  - Pendant cord
- Check to make sure all plugs are fully inserted or attached.

## BED FRAME & SLEEPING SURFACE

- Visually check all welds.
  - Head section
  - Foot section
  - Main Frame
- Check joints between sleeping surface sections for loose fasteners.

## CLEANING

- If possible, remove patient/resident before cleaning bed.
- Prior to cleaning unplug power supply cord
- Ensure all electrical parts (motors, control boxes, wires and pendant) are not broken. Ensure that NO liquids enter electrical components.
- The metal parts of the bed are covered with a powder coating. Clean all coated parts with mild detergent and warm water.
- Raise head and foot sections of the bed to remove dust from frame.
- Remove mattress and clean mattress deck.
- Remove all gross/solid contaminants, then wash and sanitize all components. DO NOT submerge the bed frame or electrical components.
- Solvents, alcohol, bleach, caustic agents, high acid or alkaline solutions or petroleum based products should not be used on the bed.
- Use standard water pressure. DO NOT power wash or steam clean any parts.
- Rinse completely with water (Maximum temperature 110°F or 43°C). Do not rinse with cold water.
- Ensure all parts are dry before using or storing.

NOTE: This bed is NOT compatible with wash down tunnels.

## LUBRICATION & MECHANICAL

- Lightly grease all actuator screw threads with white lithium grease.
- Lubricate all caster roller and swivel bearings with light machine oil.
- Check all bolts and tighten as needed.

## WARRANTY

- Lifetime warranty on welds.
- 5 year warranty on frame.
- 5 year warranty on motor and pendant.
- 1 year warranty on all other parts and components.

During the warranty period, defective items will be repaired or replaced at Drive's option at no charge.

# MAINTENANCE & SAFETY CHECKS

## PARTS

Drive DeVilbiss Healthcare beds contain a variety of parts that wear from normal use. Drive DeVilbiss Healthcare's responsibility under this warranty is limited to supplying replacement parts, servicing or replacing, at its option, which are found to be faulty by Drive DeVilbiss Healthcare. For warranty replacement, Drive DeVilbiss Healthcare may request that broken parts be sent back to them for evaluation. A credit will be issued only after the inspection and determination of cause.

## SERVICE

A majority of service requests can be handled by the local Distributor/Provider's maintenance department with assistance from Drive DeVilbiss Healthcare tech support. If a Drive DeVilbiss Healthcare technician is required, one will be provided by Drive DeVilbiss Healthcare at our discretion.

Most parts can be shipped next day air at the customer's expense.

This warranty is extended to the original purchaser of the equipment.

## SALES AND SERVICE

Contact Drive DeVilbiss Healthcare if you need any help with installation, usage or maintenance of the product.

Corporate Office: Drive DeVilbiss Healthcare, 99 Seaview Blvd., Port Washington, NY 11050

Ph: 1-877-224-0946 Fax: 516-988-4601

Website: [www.drivemedical.com](http://www.drivemedical.com)

## END OF LIFE DISPOSAL

- Many components of this product may be recycled.
- Please dispose of non-recyclable items properly.



This marking indicates that this product should not be disposed with other household wastes. To prevent possible harm to the environment or human health from uncontrolled waste disposal, recycle responsibly to promote the sustainable reuse of material resources. To safely recycle your used device, please follow local governing ordinances and recycling guidelines regarding disposal of the product or its components.

**NOTE:** The information within this document is subject to change without notice. This manual includes important information about safety of personnel and equipment. As you read through this manual be aware of the four signal indicators.

# WARNINGS

## GENERAL WARNINGS

**DO NOT** use this product or any available optional equipment without first completely reading and understanding these instructions and any additional instructional material such as owner's manuals, service manuals or instruction sheets supplied with this product or optional equipment. If you are unable to understand the warnings, cautions or instructions, contact a healthcare professional, dealer or technical personnel before attempting to use this equipment - otherwise, injury or damage may occur.

Read all the instructions before using the bed.

Refer to the owner's manuals for beds and rails for additional product and safety information.

After any adjustments, repair or service and before use, make sure all attaching hardware is tightened securely.

After the bed has been assembled, always test to make sure that all sections of the bed are properly and securely in place before using.

**ALWAYS** use caster locks except when moving the bed.

Body weight should be evenly distributed over the surface of the bed. **DO NOT** lay, sit or lean in such a way that your entire body weight is placed only on raised head or foot sections of the bed. This includes when assisting the user in repositioning or transferring in or out of bed.

Check all parts for shipping damage and test before using. In case of damage, **DO NOT** use. Contact a qualified technician for further instruction.

Close supervision is necessary when this bed is used by or near children or people with disabilities.

**DO NOT** let any individual underneath the bed or in between the raised bed frame components at anytime.

**DO NOT** permit more than one person on/in the bed at any time.

**DO NOT** use outdoors.

For Dealers Only - Set-up and Assembly Instructions are in the front of this manual. These procedures must be performed by qualified technicians only.

The March 2006 version of the FDA's bed safety guidelines are published by Hospital Bed Safety Workgroup. The latest revision of this document is available at <http://www.fda.gov>.

If the unit is not working properly, call a qualified technician to examine the unit and repair it.

Drive Medical products are specifically designed and manufactured for use in conjunction with Drive Medical accessories. Accessories designed by other manufacturers have not been tested by Drive Medical and are not recommended for use with Drive Medical products.

Keep all moving parts, including the main frame, mattress deck (head and foot sections) and all drive shafts free of obstruction (i.e. blankets/sheets, heating blankets/pads, tubing, wiring, etc. and other types of products using electric cords which may get tangled around the bed, side rails or legs) during operation of the bed.

Keep the product a minimum of 12 inches away from any direct heat source.

Make sure head and foot sections are locked in place and connected securely to the bed ends before use.

Physically challenged individuals who cannot prevent themselves from rolling/climbing out of the this bed may require alternative safe means of restraint.

Procedures other than those described in this manual must be performed by a qualified technician.

Risk of injury to persons - **DO NOT** place video equipment such as televisions or computer monitors on bed.

**NEVER** allow patients to use trapeze or traction units as a total individual weight support.

Trapeze units are to be used only for assisting the patient in repositioning or transferring into or out of bed.



# WARNINGS

Trapeze units must be positioned on a bed end as close as possible to the center point of the bed end.

The bed is not designed to be used as a patient transport. When transporting a patient, use an approved patient transport device. Otherwise, injury or damage may result.

The bed may be equipped with locking casters. When transferring into or out of the bed, always lock the locking caster(s). Inspect for correct locking action on caster locks before using bed. Even with casters properly locked, some flooring surfaces such as tile or wood, will allow the bed to move under some conditions. Use on surfaces such as these must be evaluated by the care provider.

The initial set up of this bed must be performed by a qualified technician.

The total weight limit of the Drive Medical 36 inch (91.4cm) wide Manual/Semi-Electric/Full Electric bed is 450 pounds (204 kg) which includes the weight of the occupant, all accessories such as mattress, side/assist rails, trapeze, any personal effects, etc.

Example: If total weight of mattress and all accessories is 100 lbs, then total occupant weight can be no more than 350 lbs.

Use this bed only for its intended use as described in these instructions. **DO NOT** use attachments not recommended by the manufacturer.

After raising/lowering the head/foot end of the bed, check the distance between the bottom of the bed rail and the mattress. If there is excessive distance between the bottom of the bed rail and the mattress in which individuals may become entangled, adjust the height of the bed rail (if applicable), or provide alternative means of patient protection.

Once patient assessment concludes that the patient's condition increases the chance of entrapment, the bed **MUST** be in the flat position when left unattended.

Proper patient assessment and monitoring, and proper maintenance and use of equipment is required to reduce the risk of entrapment. Variations in bed rail dimensions, and mattress thickness, size or density could increase the

risk of entrapment. Visit the FDA website at <http://www.fda.gov> to learn about the risks of entrapment.

Replacement mattresses and bed side rails with dimensions different than the original equipment supplied or specified by the bed frame manufacturer are not interchangeable. Variations in bed side rail design, width and thickness or firmness of the mattress could cause/ contribute to entrapment. Use only authorized Drive Medical replacement parts and/or accessories otherwise the warranty is void. Drive Medical will not be responsible for any damage or injury that may result.

To reduce the risk of entrapment make certain that the bed rail cross braces **DO NOT** exceed the width of the mattress. Mattress **MUST** fit bed frame and side rails snugly to reduce the risk of entrapment.

When operating this bed, **ALWAYS** ensure that the individual utilizing the bed is positioned properly within the confines of the bed. **DO NOT** let any extremities protrude over the side or between the bed rails when performing these functions.

Drive Medical recommends that the mattress be centered on the bed frame. Otherwise, individuals may become entangled between the bed rail and the bed frame.

Mattress **MUST** fit bed frame and assist rails snugly to reduce the risk of entrapment.

## SAVE THESE INSTRUCTIONS

**NOTE:** Updated versions of this manual are available on [www.DriveMedical.com](http://www.DriveMedical.com).

# TROUBLESHOOTING GUIDE



## WARNING

Before doing any repairs or maintenance to the bed frame, read all instructions, cautions, and warnings. Repairs should be done by a skilled technician.

Problem	Solution
<p>Full Electric Semi Electric</p> <p>If bed movement does not occur when pendant control button is pushed.</p>	<ol style="list-style-type: none"> <li>1. Adjustment may already be at maximum or minimum level.</li> <li>2. Bed is not plugged into wall outlet. Plug bed into wall outlet.</li> <li>3. Repeated adjustments or use of multiple adjustments simultaneously may trip thermal protection overload. Allow bed to sit for several minutes to reset. This can take up to 30 minutes depending on overload severity.</li> <li>4. Pendant cord may be damaged. Check cord for damage. If cord is damaged, discontinue bed usage until cord is replaced.</li> <li>5. Pendant connection may be loose or damaged. Reconnect the pendant to the connection on motor housing.</li> <li>6. Bed may be overloaded or constrained from moving. Determine load and check for obstructions.</li> <li>7. Household fuse or circuit breaker blown. Check and reset.</li> <li>8. If motors are still not working after checking all of the above possibly solutions – Call Local Provider.</li> </ol>
<p>Bed is making unusual sounds, burning odors or sporadic movements.</p>	<p>Call Local Provider.</p>
<p>Bed does not stay in place</p>	<p>Check Caster locks to ensure they are engaged</p>
<p>Bed Deck does not elevate</p>	<p>Check pull tube(s) for proper installation and ensure spring button is properly locked in position into outer tube</p>
<p>Bed Ends move in opposite directions</p>	<p>Ensure bed has been assembled with designated “Head” and “Foot” Bed Ends</p>
<p>If Bed will not Raise and Lower</p>	<ol style="list-style-type: none"> <li>1. Ensure Gear Box Crank connections on both Bed Ends are facing outward so accessible to hand crank.</li> <li>2. Ensure Hand Crank is properly engaged into bed end gear box (Semi &amp; Manual).</li> <li>3. Drive Shaft may not be installed or is incorrectly installed. Ensure Drive Shaft is properly connected to both Bed End gear boxes.</li> <li>4. To work properly, Bed Ends must be installed as a set: Bed End at Head Section will say “HEAD” on the top and sides and at the Foot Section will say “FOOT” on the top and sides.</li> </ol>
<p>Drive Shaft is too long or too short</p>	<ol style="list-style-type: none"> <li>1. Depress adjustment pin and extend/retract shaft to position in the correct hole location</li> </ol>



# APPENDIX

## SPECIAL NOTE

For your convenience, we have provided the April 2010 edition of the FDA's guide to bed safety. This information from the FDA's brochure, published by Hospital Bed Safety Workgroup, is replicated verbatim; the latest version is available at <http://www.fda.gov>.

## A Guide to Bed Safety Bed Rails in Hospitals, Nursing Homes and Home Health Care: The Facts

### Bed Rail Entrapment Statistics

Today there are about 2.5 million hospital and nursing home beds in use in the United States. Between 1985 and January 1, 2009, 803 incidents of patients\* caught, trapped, entangled, or strangled in beds with rails were reported to the U.S. Food and Drug Administration. Of these reports, 480 people died, 138 had a nonfatal injury, and 185 were not injured because staff intervened. Most patients were frail, elderly or confused.

\* In this brochure, the term patient refers to a resident of a nursing home, any individual receiving services in a home care setting, or patients in hospitals.

### Patient Safety

Patients who have problems with memory, sleeping, incontinence, pain, uncontrolled body movement, or who get out of bed and walk unsafely without assistance, must be carefully assessed for the best ways to keep them from harm, such as falling. Assessment by the patient's health care team will help to determine how best to keep the patient safe. Historically, physical restraints (such as vests, ankle or wrist restraints) were used to try to keep patients safe in health care facilities. In recent years, the health care community has recognized that physically restraining patients can be dangerous. Although not indicated for this use, bed rails are sometimes used as restraints. Regulatory agencies, health care organizations, product manufacturers and advocacy groups encourage hospitals, nursing homes and home care providers to assess patients' needs and to provide safe care without restraints.

### The Benefits and Risks of Bed Rails

Potential benefits of bed rails include:

- Aiding in turning and repositioning within the bed.
- Providing a hand-hold for getting into or out of bed.
- Providing a feeling of comfort and security.
- Reducing the risk of patients falling out of bed when being moved.
- Providing easy access to bed controls and personal care items.

Potential risks of bed rails may include:

- Strangling, suffocating, bodily injury or death when patients or part of their body are caught between rails or between the bed rails and mattress.
- More serious injuries from falls when patients climb over rails.
- Skin bruising, cuts, and scrapes.
- Inducing agitated behavior when bed rails are used as a restraint.
- Feeling isolated or unnecessarily restricted.
- Preventing patients, who are able to get out of bed, from performing routine activities such as going to the bathroom or retrieving something from a closet.

### Meeting Patients' Needs for Safety

Most patients can be in bed safely without bed rails. Consider the following:

- Use beds that can be raised and lowered close to the floor to accommodate both patient and health care worker needs.
- Keep the bed in the lowest position with wheels locked.
- When the patient is at risk of falling out of bed, place mats next to the bed, as long as this does not create a greater risk of accident.
- Use transfer or mobility aids.
- Monitor patients frequently.

- Anticipate the reasons patients get out of bed such as hunger, thirst, going to the bathroom, restlessness and pain; meet these needs by offering food and fluids, scheduling ample toileting, and providing calming interventions and pain relief.

When bed rails are used, perform an on-going assessment of the patient's physical and mental status; closely monitor high-risk patients. Consider the following:

- Lower one or more sections of the bed rail, such as the foot rail.
- Use a proper size mattress or mattress with raised foam edges to prevent patients from being trapped between the mattress and rail.
- Reduce the gaps between the mattress and side rails.

### **Which Ways of Reducing Risks are Best?**

A process that requires ongoing patient evaluation and monitoring will result in optimizing bed safety. Many patients go through a period of adjustment to become comfortable with new options. Patients and their families should talk to their health care planning team to find out which options are best for them.

### **Patient or Family Concerns about Bed Rail Use**

If patients or family ask about using bed rails, health care providers should:

- Encourage patients or family to talk to their health care planning team to determine whether or not bed rails are indicated.
- Reassure patients and their families that in many cases the patient can sleep safely without bed rails.
- Reassess the need for using bed rails on a frequent, regular basis.

To report an adverse event or medical device problem, please call FDA's Med Watch Reporting Program at 1-800-FDA-1088.

For additional copies of this brochure, see the FDA's Hospital Bed website.

For more information about this brochure, contact Beryl Goldman at 610-335-1280 or by e-mail at [bgoldman@kendaloutreach.org](mailto:bgoldman@kendaloutreach.org). She has volunteered to answer questions.

For information regarding a specific hospital bed, contact the bed manufacturer directly.

### **Developed by the Hospital Bed Safety Workgroup**

Participating Organizations:

- |  |   |
|--|---|
| • AARP   | • ECRI  |
| • ABA Tort and Insurance Practice Section  | • Evangelical Lutheran Good Samaritan Society                   |
| • American Association of Homes and Services for the Aging                         | • Hill-Rom Co., Inc.  |
| • American Health Care Association   | • Joerns Healthcare, Inc.                                       |
| • American Medical Directors Association   | • Joint Commission on Accreditation of Healthcare Organizations |
| • American Nurses Association  | • Medical Devices Bureau, Health Canada                         |
| • American Society for Healthcare Engineering of the American Hospital Association | • National Association for Home Care                            |
| • American Society for Healthcare Risk Management                                  | • National Citizens' Coalition for Nursing Home Reform          |
| • Basic American Metal Products  | • National Patient Safety Foundation                            |
| • Beverly Enterprises, Inc.  | • RN+ Systems   |
| • Care Providers of Minnesota  | • Stryker Medical   |
| • Carroll Healthcare   | • The Jewish Home and Hospital                                  |
| • DePaul College of Law  | • Untie the Elderly, The Kendal Corporation                     |
|  | • U.S. Food and Drug Administration                             |



99 Seaview Boulevard  
Port Washington, NY 11050

Phone: 516-998-4600

Toll Free: 877.224.0946

Fax: 516.998.4601

[www.drivemedical.com](http://www.drivemedical.com)