



PRIMECARE®
P903 Long Term Care Bed
OWNER'S MANUAL



*Shown with Optional Deluxe
Rotating Assist Rails

Manual must be given to the Owner/User of this bed and should be read carefully before putting this product into use. Keep manual in an accessible location for future reference.

99 SEAVIEW BLVD.
PORT WASHINGTON, NY 11050
PHONE | 877-374-8763
FAX | 516-998-4601
WWW.DRIVEMEDICAL.COM

TABLE OF CONTENTS

STANDARD SYMBOLS USED IN THIS MANUAL	2
WARNING LABELS.....	3
INTENDED USE	4
CONTRA-INDICATIONS	4
GENERAL SAFETY	4
LEFT/RIGHT REFERENCE GRAPHIC	9
ELECTROMAGNETIC EMISSION AND IMMUNITY.....	9
FEATURES AND ACCESSORIES.....	13
TECHNICAL SPECIFICATIONS	14
COMPLIANCE INFORMATION	15
UNPACKING INSTRUCTIONS	16
ASSEMBLY	17
ACCESSORY INSTALLATION.....	21
BED OPERATION	37
BED MOBILIZATION AND STABILIZATION	41
CARE AND MAINTENANCE	43
INSPECTIONS	44
SERVICING	46
TROUBLESHOOTING GUIDE	48
WARRANTY.....	49
END OF LIFE DISPOSAL	51
APPENDIX	51

NOTE: DO NOT operate this product without first reading and understanding this user manual. Damage or injury may result from improper use of this product.

STANDARD SYMBOLS USED IN THIS MANUAL

This manual includes important information about the safety of personnel and equipment. As you read through this manual be aware of the symbols and their meanings.



DANGER

Information that appears under the DANGER symbol concerns the protection of personnel from direct and pending hazards that, if not avoided, will result in immediate, serious personal injury or death in addition to damage of the equipment.



DANGER SHOCK HAZARD

Information that appears under the DANGER SHOCK HAZARD symbol concerns the protection of personnel from possible hazards related to electrical shock.



FIRE HAZARD

Information that appears under the FIRE HAZARD symbol concerns the protection of personnel from possible hazards related to fire and flammability.



WARNING

Information that appears under the WARNING symbol concerns the protection of personnel from possible hazards that can result in injury or death in addition to damage of the equipment.



CAUTION

Information that appears under the CAUTION symbol concerns the protection of personnel from possible hazards that may result in minor injury or damage of the equipment.



CRUSH HAZARD

Information that appears under the CRUSH HAZARD symbol concerns the protection of personnel from possible hazards related to reduce clearances.

NOTE:

Information that appears with the NOTE text gives added information, which helps in understanding the item being described.

PRODUCT SYMBOLS

Symbols	Description	Symbols	Description
	Type B applied part equipment		Recycle the item in accordance with local regulations.
IP66	According to IEC 60529. Rating for dust-protection and identified as equipment that is protected against powerful water jets	 ETL CLASSIFIED C LISTED US Intertek 3188074	Intertek's ETL listed mark for US and Canada. A product bearing the ETL listed Mark is determined to have met the minimum requirements of prescribed product safety standards.
	Class II equipment	 250kg (550lbs) 272kg (600lbs)	Maximum patient weight and safe working load
	The owner's manual must be read before operating the bed.		

WARNING LABELS

	<p>WARNING</p> <p>Mattress must fit Bed Frame and Assist Rail snugly to help prevent patient entrapment. Patient entrapment with Assist Rail may cause injury or death. Please follow the manufacturer's instructions and monitor patient frequently. Please read and understand the Owner/Operator Manual prior to using this bed.</p> <p>P/N:TW60000015E REV:000</p>		<p>WARNING</p> <p>Utilisez un matelas dont les caractéristiques correspondent parfaitement au lit et au support Assist Rail pour éviter que le patient ne se coince. Le fait de se coincer avec ce produit peut causer des blessures ou être fatal. Veuillez suivre les instructions du fabricant et surveiller le patient fréquemment. Veuillez lire et comprendre le Guide du propriétaire / de l'utilisateur avant d'utiliser ce lit.</p> <p>P/N: TW60000016E REV:000</p>
	<p>WARNING</p> <p>Incompatible MATTRESSES can create hazards. READ INSTRUCTIONS FOR USE.</p> <p>MATELAS incompatibles peuvent créer risques. LISEZ LES INSTRUCTIONS D'UTILISATION.</p> <p>P/N:TU60000005E REV:000</p>		<p>WARNING</p> <p>Incompatible SIDE RAILS can create hazards. READ INSTRUCTIONS FOR USE.</p> <p>SIDE RAILS incompatibles peuvent créer risques. LISEZ LES INSTRUCTIONS D'UTILISATION.</p> <p>P/N:TW60000023E REV:000</p>
	<p>WARNING</p> <p>DO NOT place feet beneath the Rotating Assist Rail/Bar when lowering the bed. Before lowering the bed, ensure the Rotating Assist Rail/Bar is in the locked and raised position.</p> <p>P/N:TW60000022E REV:000</p>		<p>WARNING</p> <p>Ne placez pas vos pieds sous la barre de protection //l'appui-bras lors de la descente du lit. Veuillez assurer que la barre de protection //l'appui-bras est en position relevée et verrouillée avant de la descente du lit.</p> <p>P/N:TW60000025E REV:000</p>
	<p>WARNING</p> <p>Stay clear of the Bed Frame and ensure children, pets or other items are not under the bed before lowering. Crush point exists due to LOW BED CLEARANCE. Lowering the bed without care may cause INJURY.</p> <p>P/N: TB60000017E REV:000</p>		<p>WARNING</p> <p>Dégagez le cadre du lit et assurez-vous qu'il n'y a pas d'enfant, d'animal ou d'autres objets sous le lit avant de l'abaisser. Il existe un risque de coincement dû au FAIBLE DÉGAGEMENT SOUS LE LIT. Abaisser le lit sans faire ces vérifications peut causer des BLESSURES.</p> <p>P/N: TB60000015E REV:000</p>
	<p>WARNING</p> <p>Prior to use read all instructions and warnings in the Owner's Manual. Death or serious injury may result.</p> <p>P/N:TW60000021E REV:000</p>		<p>WARNING</p> <p>Avant utilisation, veuillez lire les instructions et les avertissements dans le mode d'emploi. Sinon, entraînera la mort ou des blessures graves.</p> <p>P/N:TW60000024E REV:000</p>
	<p>WARNING</p> <p>DO NOT put hands into designated openings. Crush point may cause INJURY.</p> <p>P/N: TB60000016E REV:000</p>		<p>WARNING</p> <p>Ne mettez pas les mains à l'intérieur de l'ouverture designés. Le point d'écrasement peut causer des blessures.</p> <p>P/N: TB60000014E REV:000</p>

INTENDED USE

The PrimeCare P903 bed is intended for use within an institutional healthcare environment, Application Environment 3 (i.e.: Skilled Nursing, Transitional Care, Rehabilitation Care, Assisted Living).

Compliance with the regulations and guidelines as specified by your facility is recommended.

This bed is **NOT** intended for patient/resident transport. Wheels are provided only to allow movement within the patient/resident room for cleaning or patient/resident access.

CONTRA-INDICATIONS

This bed should not be operated (control the movements of the bed through the control interfaces) by persons who do not have the cognitive skills to understand the information in the owner's manual or cannot understand and perform the proper operation of the bed. This bed should not be used or operated by children.

GENERAL SAFETY

NOTE: *In this manual, the terms patient and resident refer to a resident of a nursing home, Long Term Care, assisted living or rehabilitation facility.*



WARNING

- **NEVER** allow anyone under the bed at any time.
- DO NOT let any body parts protrude over the side or between parts, especially when the bed is being operated.
- This bed should not be placed in an oxygen enriched environment.
- Unplug bed or stop pressing pendant button when bed does not function as expected.
- DO **NOT** operate this product without first reading and understanding this user manual. Damage or injury may result from improper use of this product.
- Possible injury or Death may occur if accessories are not provided by Drive DeVilbiss Healthcare. Please contact Drive DeVilbiss Healthcare for accessories that are compatible with this bed.
- Possible injury or Death may occur if replacement parts are not provided by Drive DeVilbiss Healthcare. Please contact Drive DeVilbiss Healthcare for replacement parts compatible with this bed.



WARNING

- Power cord must be plugged into appropriate wall outlet, ensuring it can be unplugged easily in case of an emergency.
- **Never** permit more than one (1) person in/on the bed at any time. Never exceed the weight capacity of this bed. The maximum safe working load for this bed including resident/patient, bedding, support surface and accessories is **600lbs (272kg)**, with weight evenly distributed and the maximum patient weight is **550 lbs (249.5kg)**. The weight of the accessories are show as below:

ACCESSORY DESCRIPTION	DRIVE PRODUCT CODE	WEIGHT
Head/Foot Board	Multiple Options	19.8 lbs (9kg)
Mattress	Multiple Options	21 lbs (9.5kg)
Deluxe Rotating Assist Rail (pair)	PLTCDR	24.2 lbs (11kg)
Rotating 1/4 Assist Rail (pair)	PLTCAR	18 lbs (8.2kg)
Rotating Assist Bar (pair)	PLTCAB	11.9 lbs (5.4kg)
Trapeze	P903TPZ	37 lbs(17kg)
Staff Control Panel	P903SC05	0.7 lbs(0.3kg)
Battery Backup	P903-T-BBK	2.64 lbs(1.2kg)

Note: Maximum patient weight may be less than stated if more than 50lbs accessories are placed on the bed frame.

- The medical bed should be left in its lowest position except when care is being provided in order to reduce risk of injury due to falls.
- The bed **MUST** be connected to an appropriate power source. Unless equipped with the optional battery backup, this bed will not operate when not plugged in. Mains cable and proper function must be checked regularly.
- Possible Injury or Death may occur if bed is pushed over abrupt thresholds while bed is occupied. This bed is not intended for patient/resident transport. Please use an approved resident transport device when moving a resident.

**DANGER SHOCK HAZARD**

- DO NOT plug anything into the control box of bed (i.e. pendants and actuators) while mains cable (power cord) is plugged into the wall outlet.
- Any cords or tubing used on or with this bed **MUST** be routed and secured properly to ensure that they do NOT become entangled, kinked or severed during normal operation of the bed.
- DO NOT roll the bed over any power or pendant cords.
- This bed is equipped with a three-prong grounding plug for protection against possible shock hazard. DO NOT under any circumstances cut or remove the grounding prong.
- DO NOT open any actuators, control boxes, pendants or battery. Service and repair must only to be performed by authorized service personnel. If unauthorized service is performed on any components the warranty is void.
- Inappropriate handling of power supply cords can create a shock hazard.
- When routing cables from other equipment in the medical bed, precautions shall be taken to avoid squeezing those between parts of the medical bed.
- DO NOT allow the cord, electrical outlets, and electrical control box or hand pendant to become wet or submerged.
- DO NOT operate the bed if any electrical component such as the power cord, electrical outlet, connections, motor/actuator or mechanical component has malfunctioned or has been damaged in any way.
- To avoid risk of electric shock, this equipment must only be connected to a supply mains with protection earth.
- The bed **MUST** be connected to an appropriate power source. Unless equipped with the optional battery backup, this bed will not operate when not plugged in. Mains cable and proper function must be checked regularly.
- Possible injury or Death may occur due to pendant cord being a source for entangling patient/resident. Patients/residents with decreased mental acuity should NOT have access to pendant.



FIRE HAZARD

- DO NOT use near open flame or explosive gases.
- Possible Fire Hazard if used with nasal mask in 1/2 bed tent O₂ administering equipment. If O₂ tent is being used it should not fall below the mattress deck. The pendant should not be placed in an oxygen enriched environment such as an O₂ tent.
- This bed should not be placed in an oxygen enriched environment.



CAUTION

- This medical bed is not intended to work with patient lifts other than those specified by Drive DeVilbiss Healthcare as being compatible.
- Do **NOT** use rotating assist bars/rails as handles for moving the bed.
- Keep all moving parts, including the mattress deck (sleep surface), main frame, all drive actuators and moving components free of obstructions.
- Ensure that the individual using this bed is properly positioned, particularly when the bed is being operated.
- Body weight should be evenly distributed over the sleeping surface of the bed. Avoid situations where entire body weight is on a raised head or foot surface. This includes while assisting the resident in repositioning or transferring in or out of bed.
- Supervision is required when this product is operated by or near children or people with disabilities.
- Do not modify this bed without authorization of the manufacturer. If unauthorized service is performed on any components the warranty is void.
- This bed frame complies with EMC requirements of IEC 60601-1-2. Radio transmitting equipment, cell phones or similar electronic devices, used in proximity of the bed, may affect the beds performance.



CRUSH HAZARD

- Possible crush hazard exists when pressing the Foot Lock Mechanism to the floor. This feature was designed to be activated by your foot. Using your hand could result in injury. Keep feet out from under Foot Lock Mechanism when activating.
- Possible crush hazard exists between the floor and the square tubes used for mounting rotating assist bars/rails. Keep feet out from under the square tubes on the edge of the bed while operating the bed.
- Possible Injury may occur when lowering or raising the bed. Keep feet and hands clear of bed frame
- Do not put your hands/fingers into the opening of thigh deck edges, crush point may cause injury to your hands/fingers.



ENTRAPMENT WARNING

- The entrapment issues can still arise when components and accessories are not properly installed.
- If a resident/patient's mental or physical condition could lead to resident/patient entrapment, the mattress deck (sleep surface) should be left in the flat position when unattended. Failure to do so could result in injury or death.
- Incompatible mattress and assist rails/bars can create hazards. Only compatible Drive DeVilbiss Healthcare rotating assist bars and rails may be used on this bed. Make sure mattress is the correct size for bed frame and the assist bars are secured to frame to decrease the risk of entrapment.
- If bed frames have been serviced or any other adjustments have been made, you must ensure all parts are securely back in place before operating the bed.



MATTRESS SPECIFICATIONS WARNING

Possible ENTRAPMENT Hazard may occur if you do not use the recommended specification mattress.

Resident entrapment may occur leading to injury or death.

- A mattress may not be included with this bed. It is recommended that a 36", 39", or 42" wide mattress that is made to fit an 80", 84" or 88" length bed frame is used, such as a Drive DeVilbiss Healthcare Pressure Redistribution Mattress. Mattress height must be a minimum of 5-1/2 inches and a maximum of 7 inches.
- Also available are Drive DeVilbiss Healthcare's assortment of mattress overlays and Low Air Loss flotation mattress systems.
- See Technical Specifications page for compatible mattress dimensions.

LEFT/RIGHT REFERENCE GRAPHIC

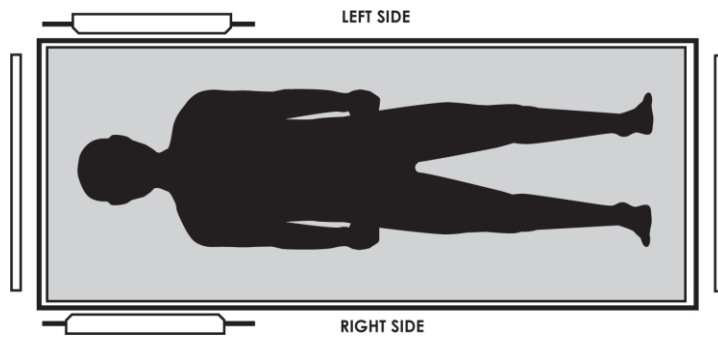

ELECTROMAGNETIC EMISSION AND IMMUNITY

This MEDICAL ELECTRICAL EQUIPMENT needs special precautions regarding EMC and needs to be installed and put into service according to the EMC information provided in the table below.

Portable and mobile RF communications equipment can affect MEDICAL ELECTRICAL EQUIPMENT



WARNING

The use of ACCESSORIES, transducers and cables other than those specified, with the exception of transducers and cables sold by the manufacturer of the EQUIPMENT or SYSTEM as replacement parts for internal components, may result in increased EMISSION or decreased IMMUNITY of the EQUIPMENT or SYSTEM.



WARNING

The ME EQUIPMENT or SYSTEM should not be used adjacent to or stacked with other equipment and that if adjacent or stacked use is necessary, the ME EQUIPMENT or SYSTEM should be observed to verify normal operation in the configuration in which it will be used.

DECLARATION - ELECTROMAGNETIC EMISSIONS

Guidance and manufacturer's declaration - Electromagnetic emissions		
The Prime Care TM P903 is intended for use in the electromagnetic environment specified below. The customer or the user of the Prime Care TM P903 should ensure that it is used in such an environment.		
Emissions Test	Compliance	Electromagnetic environment - Guidance
RF Emissions CISPR 11	Group 1	Uses RF energy only for its internal function. Therefore, its RF emissions are very low and are not likely to cause any interference in nearby electronic equipment.
RF Emissions CISPR 11	Class B	
Harmonic Emissions IEC 61000-3-2	Not Applicable	The Prime Care TM P903 is suitable for use in all establishments including domestic establishments and those directly connected to the public power supply network that supplies buildings used for domestic purposes.
RF emissions CISPR 14-1	Complies	The Prime Care TM P903 is not suitable for interconnection with other equipment.
RF emissions CISPR 15	Complies	

**Recommended separation distances between portable and mobile
RF communications equipment and the Prime Care™P903**

The Prime Care™P903 is intended for use in the electromagnetic environment in which radiated RF disturbances are controlled. The customer or the user of the Prime Care™P903 can help prevent electromagnetic interference by maintaining a minimum distance between portable and mobile RF communications equipment (transmitters) and the Prime Care™P903 as recommended below, according to the maximum output power of the communications equipment.

Rated maximum output power of transmitter W	Separation distance according to frequency of transmitter m		
	150 kHz to 80 MHz $d = (1,2\sqrt{P})$	80 MHz to 800 MHz $d = (1,2\sqrt{P})$	800 MHz to 2,5 GHz $d = (2,3\sqrt{P})$
0.01	0.12	0.12	0.23
0.1	0.38	0.38	0.73
1	1.2	1.2	2.3
0.1	0.38	0.38	0.73
10	3.8	3.8	7.3
100	12	12	23

For transmitters rated at a maximum output power not listed above, the recommended separation distance d in meters (m) can be estimated using the equation applicable to the frequency of the transmitter, where P is the maximum output power rating of the transmitter in watts (W) accordable to the transmitter manufacturer.

NOTE 1: At 80 MHz and 800 MHz the separation distance for the higher frequency range applies

NOTE 2: These guidelines may not apply in all situations. Electromagnetic propagation is affected by absorption and reflection from structures, objects and people.

Guidance and manufacturer's declaration: Electromagnetic Immunity			
The Prime Care™P903 is intended for use in the electromagnetic environment specified below. The customer or the user of the Prime Care™P903 should ensure that it is used in such an environment.			
Immunity test	IEC 60601 test level	Compliance level	Electromagnetic environment - guidance
<p>Conducted RF IEC 61000-4-6</p> <p>Radiated RF IEC 61000-4-3</p>	<p>3 Vrms 150 kHz to 80 MHz</p> <p>3 V/m 80 MHz to 2.5 GHz</p>	<p>10 V</p> <p>10 V/m</p>	<p>Portable and mobile RF communications equipment should be used no closer to any part of the Prime Care™P903, including cables, than the recommended separation distance calculated from the equation applicable to the frequency of the transmitter.</p> <p>Recommended separation distance</p> $d = \left(\frac{3,5}{10} \sqrt{P}\right)$ <p>$d = \left(\frac{3,5}{10} \sqrt{P}\right)$ 80MHz to 800MHz $d = \left(\frac{7}{10} \sqrt{P}\right)$ 800MHz to 2,5GHz</p> <p>Where <i>P</i> is the maximum output power rating of the transmitter in watts (W) according to the Transmitter manufacturer and <i>d</i> is the recommended separation distance in meters (m). Field strengths from fixed RF transmitters, as determined by an electromagnetic site survey, ^a should be less than the compliance level in each frequency range.^b</p> <p>Interference may occur in the vicinity of equipment marked with the following symbol:</p> 
<p>NOTE 1: At 80MHz and 800MHz the higher frequency range applies.</p> <p>NOTE 2: These guidelines may not apply in all situations. Electromagnetic propagation is affected by absorption and reflection from structures, objects and people.</p>			
<p>^a Field strengths from fixed transmitters, such as base stations for radio (cellular/cordless) telephones and land mobile radios, amateur radio, AM and FM radio broadcast and TV broadcast cannot be predicted theoretically with accuracy. To assess the electromagnetic environment due to fixed RF transmitters, an electromagnetic site survey should be considered. If the measured field strength in the location in which the Prime Care™P903 is used exceeds the applicable RF compliance level above, the Prime Care™ P903 should be observed to verify normal operation. If abnormal performance is observed, additional measures may be necessary, such as reorienting or relocating the Prime Care™ P903.</p> <p>^b Over the frequency range 150 kHz to 80 MHz, field strengths should be less than 10 V/m.</p>			

FEATURES AND ACCESSORIES

Standard Features

- 80", 84", and 88" adjustable sleep surface
- Height adjustable from 7" to 30".
- Synchronized control system.
- Roll-at-any-Height design
- Floor Lock System: Foot Pad Lock Mechanism
- Welded Tubular Steel Frame
- Slat Sleep Deck
- Wall Guard
- IV Pole Holders
- Heavy Duty 3" Dual Footprint Casters
- Adjustable Mattress Retainers
- Heel Lift Ratchet
- Under Bed Light
- 36"-39"-42" Integrated Width Extension
- Cardiac Chair Positioning
- Backlit pendant

Accessories and Options

- Pressure Reduction Mattress
- Air Flotation Mattress
- Cushion Fall Mat
- Assorted Bed End styles & colors
- Staff Control Panel
- Rotating Assist Rails & Bars
- Deluxe Rotating Assist Rails
- Battery Back-Up
- Trapeze Assembly
- Bed Transporter System



WARNING

Incompatible mattress and rotating assist bars/rails can create hazards. Read instructions for use.

Bed Serial Numbers

When ordering parts or when contacting Drive DeVilbiss Healthcare Customer Service Department, please include bed's model and serial numbers, found on the identification labels as below. The identification labels are located under the sleep deck on the either side of the bed frame.



11L: Factory Code

YY : Manufacturing Year (two digits)

MM: Manufacturing Month (two digits)

6: P903

#####: Five Sequential Digits

TECHNICAL SPECIFICATIONS

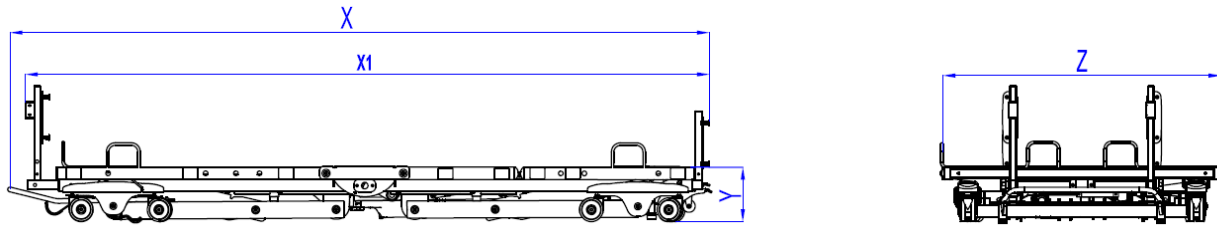

ITEM	SPECIFICATION	
Overall Length (with wall bumper) (X)	89", 93", 97"	226cm, 236cm, 246cm
Overall Length (without wall bumper) (X1)	87", 91", 95"	221cm, 231cm, 241cm
Bed height range (Y)	7" to 30"	17.8cm to 76.2cm
Overall Width without width extension* (Z)	31"	78.8cm
Overall Width with width extension	36", 39" or 42"	91.4cm, 99cm or 107cm
Length of Mattress Deck	82.6"	210 cm
Mattress Thickness Range	5.5" to 7"	14cm to 18cm
Mattress Lengths	80", 84", 88"	203cm, 213cm, 223.5cm
Mattress Width	36", 39", 42"	91.4cm, 99cm, 107cm
Weight of Bed without H/F boards or accessories	254 lbs	115 kg
Maximum Weight Capacity (SWL)**	600 lbs	272 kg
Maximum Patient Weight	550 lbs	249.5kg
Head Deck Angle Range	0° to 68°	
Thigh Deck Angle Range	0° to 30°	
Foot Deck Angle Range	0° to 10°	
Input Voltage***	100-240 VAC, 50/60 Hz	
Protective Earth Ground	CLASS II	
Electrical Shock Protection	TYPE B	
Enclosure Protection	IP66	
Duty cycle	Min. 2min (on)/ Max. 18min (off)	

NOTE: All length and height measurements $\pm .75"$, Angle measurements $\pm 3^\circ$

*Rotating Assist Bar/Rails add 3" (7.5cm) to each side of the bed

**SWL includes the weight of the resident/patient and all other accessories including, but not limited to mattresses, head/footboards, rotating assist bars, etc.

***Means of isolating equipment from supply mains:

This bed may be isolated from the supply mains by unplugging the mains cable (power cord) from the wall outlet.

COMPLIANCE INFORMATION

Matching the correct bed components to meet regulatory specifications can be complicated. Drive DeVilbiss Healthcare offers a wide variety of compliance options and we can assist your facility in selecting components or accessories that are recommended for the specific bed model.

General information

The recommended environment for operation and storage/transportation of the bed is listed below:

	Operation	Storage/Transportation
Ambient temperature:	10°C ~ 36°C (50°F~96.8°F)	-10°C ~ 50°C (14°F~122°F)
Relative humidity range:	30% ~ 75%	20% ~ 95%
Atmospheric pressure:	86KPa~ 106Kpa	70KPa~ 106KPa

This bed is classified for intermittent operation. Bed may be operated for 2 minutes out of every 20 minutes.

Applied Parts List

- Bed Frame
- Head/ Foot Board
- Rotating Assist Bars/ Rails
- Mattress Retainer
- Width Extension
- Pendant
- Trapeze
- Staff control panel

Materials accessible to user

- Surface Coating: Powder Coating
- Color of Powder: Carbon black, Ethylene Bis-Stearamide, Solvent Red
- Pendant Housing: ABS
- Staff control panel housing: ABS
- Plastic Cover of Rail/Bar: PU
- Head/Foot Board: Wood
- Trapeze: Nylon webbing

UNPACKING INSTRUCTIONS

TOOLS REQUIRED

• Pliers or Wire Cutters	• Utility Knife
--------------------------	-----------------



CAUTION

Unpack the bed in an area with sufficient room to work. Do not allow residents/patients near the bed until it has been completely set up and the work area has been cleared of all debris.

1. Inspect the bed for shipping damage. If the bed is damaged. Do not use bed and immediately contact Drive DeVilbiss Healthcare for further instruction.
2. Verify the proper bed model was shipped. If you feel there was a mistake. Do not use bed and immediately contact Drive DeVilbiss Healthcare for further instruction.
3. After verifying you've received the correct device without damage, cut black strapping around box and remove enclosing bed frame.

NOTE: *If the carton is in an upright position, slowly lower to the floor. It may be necessary for two or more people to help in lowering the bed.*

4. Cut zip ties to remove wall guard at the head of the bed.
5. Cut the zip ties to remove mattress retainers on each side of the bed.
6. Remove ties from pendant.
7. Remove any remaining zip ties or foam left on bed frame.

NOTE: *Damage to the equipment may occur if the zip ties are removed incorrectly.*



CAUTION

DO NOT remove zip ties that are holding cords underneath bed frame.

INITIAL INSPECTION

1. Inspection of All Components - Receipt of assembled bed.
2. Check bed components for obvious damage.
3. Inspect power supply cords for cuts and/or damage.
4. Check that actuator cords are connected properly to the controller.
5. Locate power cord and plug into grounded 100-240VAC outlet.
6. Raise the bed frame and check to make sure everything is plugged into the control box and no wires are loose. If wires are not in control box. Do not use bed and immediately contact Drive DeVilbiss Healthcare for further instruction.

ASSEMBLY

KNOWLEDGE/SKILLS REQUIRED

- Ability to read and understand owner's manual
- Ability to manipulate required tools
- Basic mechanical aptitude

HEADBOARD AND FOOTBOARD INSTALLATION AND ADJUSTMENT

TOOLS REQUIRED

- Philips Screwdriver



DANGER

Possible injury or death may occur if the bed is not adjusted to the proper length for the mattress being used.

1. Unscrew knobs on headboard mounting brackets, mount the headboard mounting brackets into the head board using screws.



2. Mount the footboard mounting brackets into the foot board using screws.



3. Insert assembled headboard or footboard, whichever is appropriate for the end of the bed you are working on.



4. There are mounting positions for 3 different mattress lengths, 80", 84" and 88". Choose the one appropriate for your mattress.

- Screw the knobs back in both side of the bed frame and fix headboard assemblies in place.

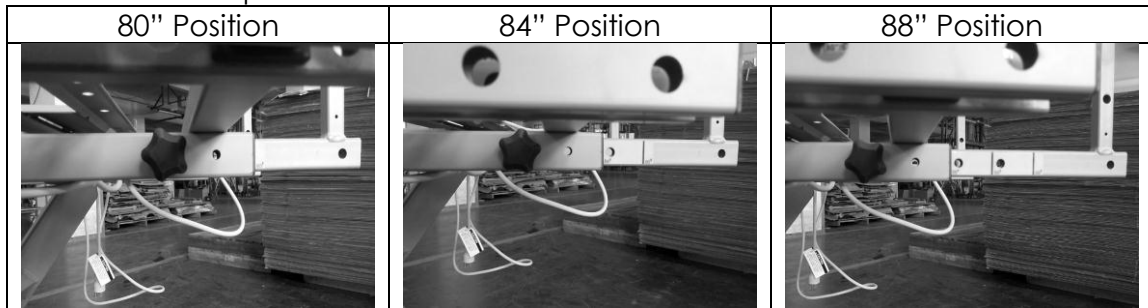

NOTE: The knobs **MUST** be installed to eliminate possible injury to the patient and damage to bed frame or its components

- Insert locking pin into both side of the bed frame and fix footboard assemblies in place.

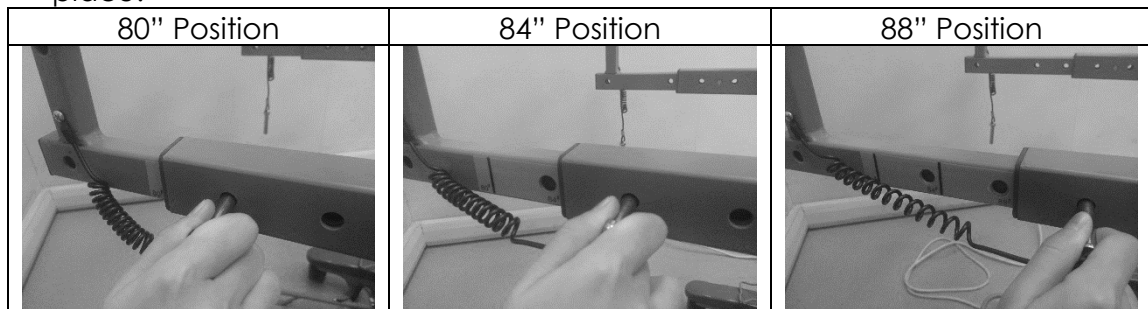

NOTE: The mounting brackets on the footboard face toward the inside of the bed. The mounting brackets on the headboard face away from the bed.

ADDITIONAL INSTRUCTIONS FOR CONTROL PANEL EQUIPPED FOOTBOARD

- Route the cable from the control panel toward the control box keeping clear of any areas that could pinch or abrade the cable.
- Secure the cable to the frame in several locations along its length using zip ties or similar products.

MATTRESS RETAINER ADJUSTMENT

Mattress retainers are designed to keep the mattress in place on the sleep surface.

1. Determine the length and width of mattress.

Length Mattress Retainer

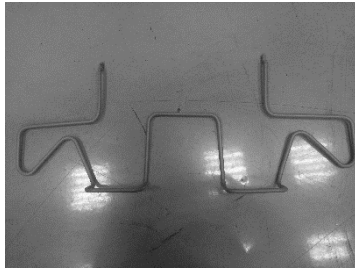

Width Mattress Retainer

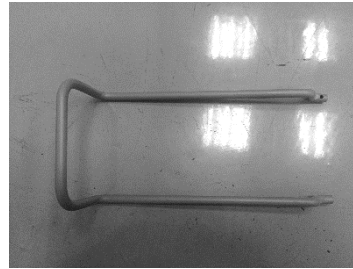

2. Place your Length mattress retainer in the correct spot.

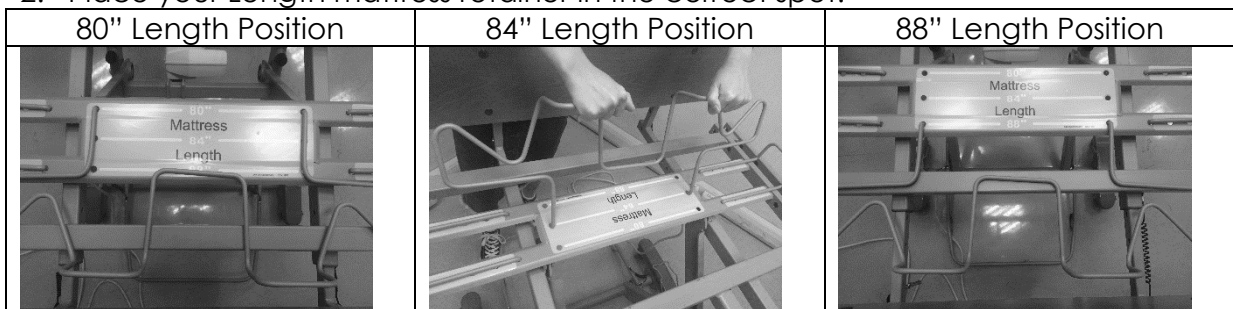

3. Place your width mattress retainer in the correct spot.

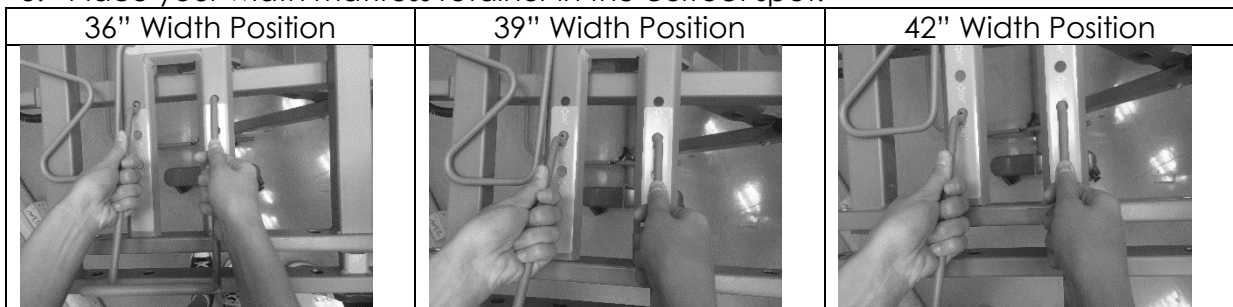

4. Place mattress on mattress support deck. The mattress should be snug against all of the mattress retainers.

NOTE: Make sure mattress fills length and width between mattress retainer stops. Also, make sure the mattress does not compress more than 1.5" under patient/resident weight.

WALL BUMPER INSTALLATION/ADJUSTMENT

The wall bumper is designed to prevent damage to facility walls by keeping the head end of the bed spaced off the wall.

1. Slide the wall bumper over the axle at the head end of the bed.

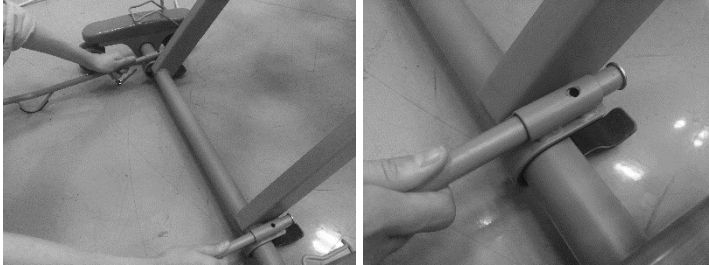

2. Insert the locking pin in the hole appropriate for the length of mattress you are using.

80" Length Position	84" Length Position	88" Length Position

WIDTH EXTENSION

Note: Both sides of the Width Extensions must be used. This will expand the bed from 36" to 39" and 42".

1. There are three (3) sections to each side of the Width Extension

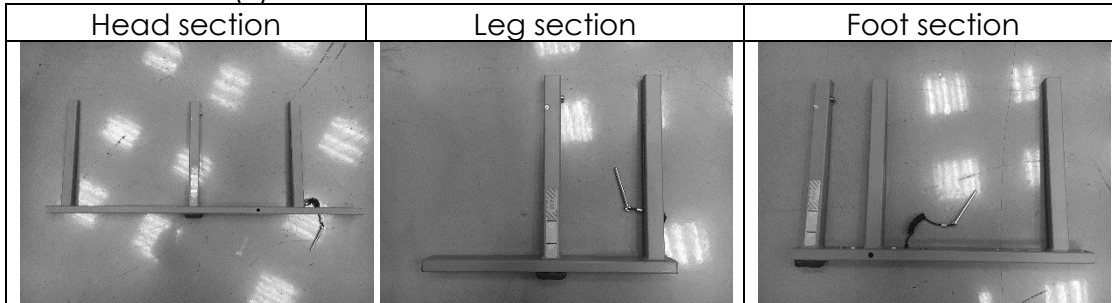

2. Push the expansion button and insert the three (3) section into the each side of the bed deck.

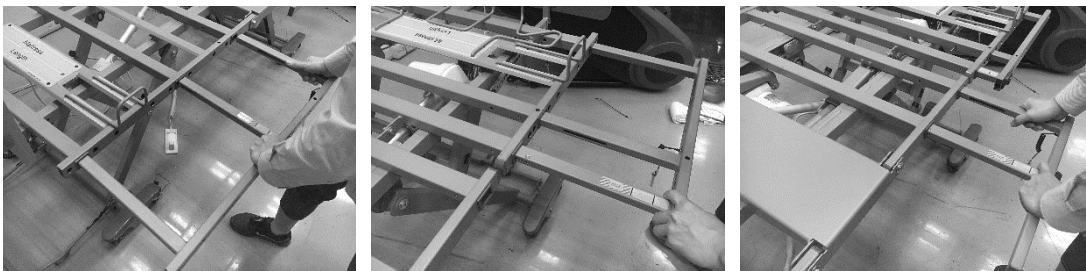

3. Choose which width the bed needs to be expanded to. This bed has 3 width settings: 36" ,39" and 42".
4. Push the expansion button in and pull out width extension until you reach the desired width of the bed deck.



5. Insert the locking pins into the bed frame to secure the width extensions.



NOTE: This bed can accommodate 36", 39" and 42" width mattress, the appropriate mattress **MUST** be used.

ACCESSORY INSTALLATION

TRAPEZE (option)

TOOLS REQUIRED

<ul style="list-style-type: none"> • 3/8" Allen wrench 	3/8" adjustable Wrench
<ul style="list-style-type: none"> • Philips screwdriver 	



WARNING

Never exceed the weight capacity of this trapeze, the maximum safe working load for this trapeze is 200lbs

Note: Trapeze ONLY can be installed at the head of the bed.

1. Remove any items on the bed such as residents, mattresses and/or sheets.
2. Raise the mattress support platform to a comfortable working height.
3. Unplug the bed from mains power.
4. Unpack the package of the trapeze. Check the hardware and components.

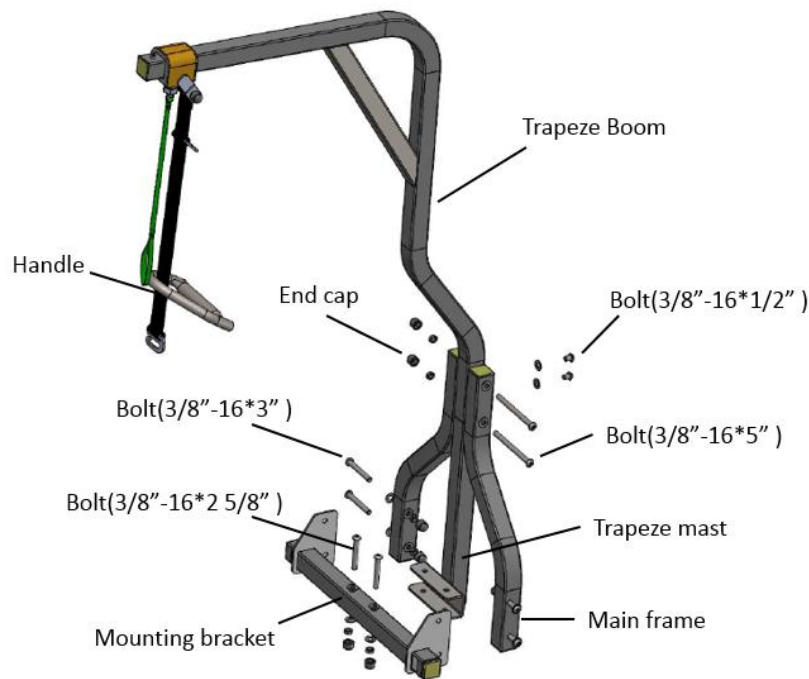

5. Insert the trapeze mast into the trapeze boom. Insert the 3/8"-16*1/2"bolt completely through the holes. Tighten the bolt and nut using Allen wrench.

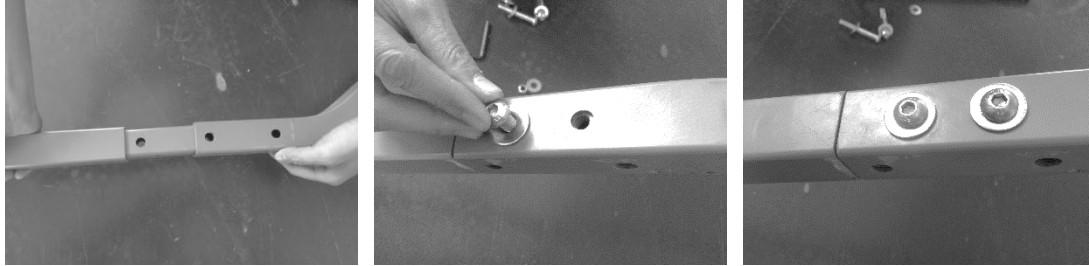

6. Assemble the mounting bracket into the trapeze mast. Insert the 3/8"-16*2 5/8" bolt completely through the holes. Tighten the bolt and nut using Allen wrench and adjustable wrench.



7. Assemble the both side of main frames into the trapeze mast. Insert the 3/8"-16*5" bolt completely through the holes. Tighten the bolt and nut using the Allen wrench and adjustable wrench.

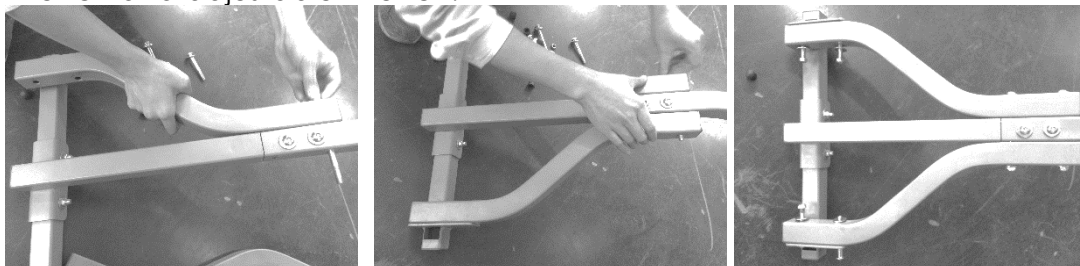

8. If the headboard is installed, remove the headboard from the bed. Remove the screws from each side of the headboard mounting bracket.

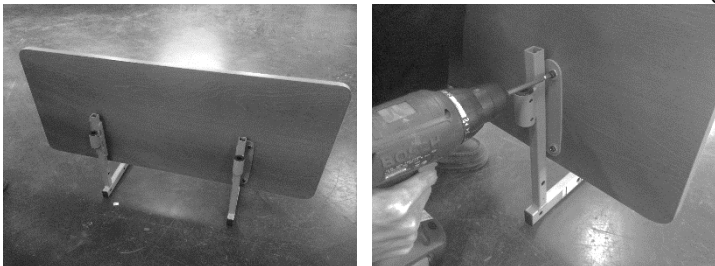

9. Insert the removed headboard mounting bracket into the trapeze mounting bracket. Secure the headboard mounting bracket with four 3/8"-16*3" bolts using Allen wrench and adjustable wrench.

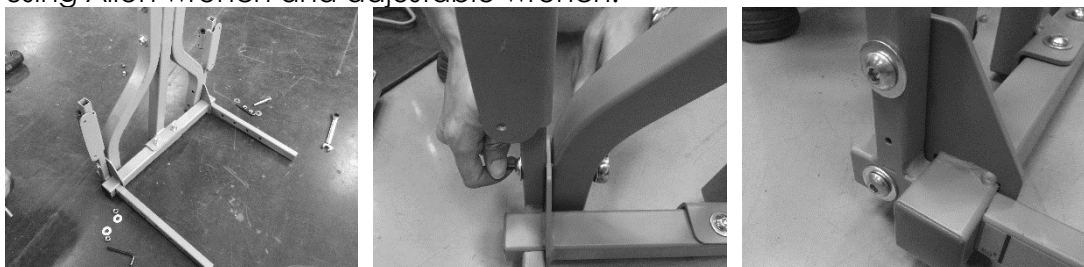

10. Assemble the headboard onto the headboard mounting bracket, and secure it with screws. Put the end caps onto each bolts. Now the trapeze is completely assembled.

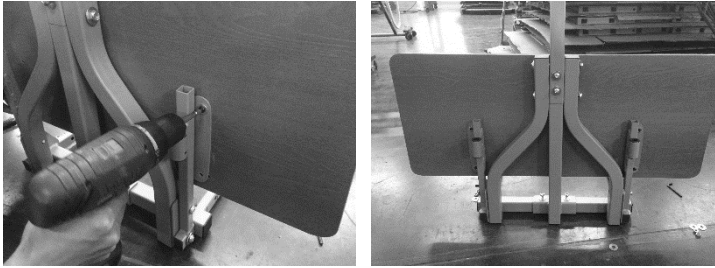

11. Insert the assembled trapeze into the head end of the bed frame.

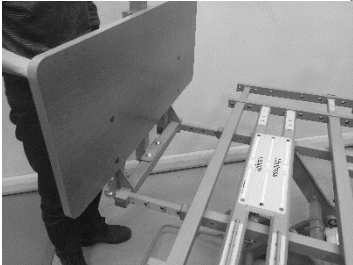

12. The label on the side of the headboard mounting bracket will help align the holes in the frame for the desired mattress length.



13. Insert the locking pin completely through the hole of bed frame, and secure the mounting bracket using knob.

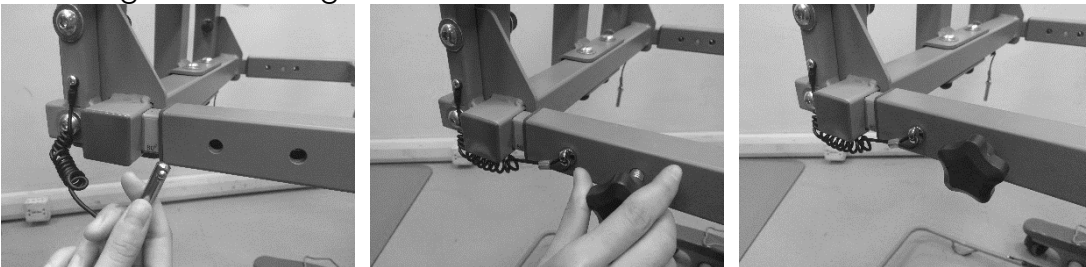

14. Adjust the wall bumper to appropriate position to accommodate the trapeze.



15. Move the bed to its desired location. Raise and lower the bed to insure that the wall bumper position chosen provides wall clearance.

ROTATING ASSIST RAIL/BAR INSTALLATION (Option)



ASSIST RAIL/BAR WARNING

Other manufacturers assist rails/bars may not be compatible and can lead to entrapment issues or harm to patients/residents. Only compatible assist rails/bars may be used on this bed. Make sure bed frame is adjusted correctly for mattress size being used and assist rails/bars are properly secured to frame to decrease the risk of entrapment.



ENTRAPMENT WARNING

The risks associated with these devices used in conjunction with specialty mattresses and mattress overlays have not been evaluated. When these specialty mattresses or mattress overlays are used, the end user facility must take steps to ensure that the therapeutic benefit outweighs the risk of entrapment.



ASSIST RAIL/BAR WARNING

Assist rails/bars are intended only to assist the resident during bed entry and exit. These devices are not side rails nor are they intended to be used in a manner that makes user entry or exit more difficult.



CAUTION

The bed may become UNSTABLE due to interference between the rotating assist bar/rail/DR and the floor when lowering the bed. An unstable bed may tilt and/or cause property damage or personal injury.



CRUSH HAZARD

Crush hazard exists between the assist rails/bars and the floor when in the lowest position which may cause injury to oneself or others. Do NOT place feet beneath the assist rails/bars.



WARNING

When routing cables from other equipment in the medical bed, precautions shall be taken to avoid squeezing between parts of the medical bed.

**ENTRAPMENT WARNING**

Accurate assessment of the resident and monitoring of correct maintenance and equipment use are required to prevent entrapment. For additional information on product and safety issues for bed frames and rails refer to product manuals specific to the product or accessories you have or are planning to install. If bed frames have been serviced or any other adjustments have been made, you must ensure all parts are securely back in place before operating the bed. Other manufacturers assist rails may not be compatible and can lead to entrapment issues or harm to residents and staff. Make sure mattress is the correct size for bed frame and the assist rails are secured to frame to decrease the risk of entrapment.

On March 10, 2006, the U.S. Food and Drug Administration (FDA) released guidelines for reducing the risk of hospital bed entrapment entitled; "Hospital bed System Dimensional and Assessment Guidance to Reduce Entrapment". This guidance document identifies potential entrapment areas within the bed frame, rails and mattress and identifies those body parts most at risk for entrapment. It also provides manufacturers with basic design criteria to consider when developing hospital/convalescent beds; recommends specific test methods to assess the conformance of existing hospital/convalescent bed systems; and answers frequently-asked questions about entrapment issues.

The FDA Guidance document identifies specific dimensional criteria on potentially injury-threatening gaps and spaces that can occur between bed system components, such as side rails when improperly installed. Drive DeVilbiss Healthcare's Long Term Care beds and approved accessories are manufactured to be in conformance with these guidelines.

Please be aware that entrapment issues can still arise when components and accessories are not properly installed on the bed. It is important for the provider or facility staff to recognize they have an equal role in complying with the FDA guidelines to help ensure resident safety and avoid injuries.

Copies of this document can be obtained from the FDA website:

<http://www.fda.gov/medicaldevices/deviceregulationandguidance/guidancedocuments/ucm072662.htm>

MOUNTING LOCATION FOR ROTATING ASSIST RAILS/BARS



CAUTION

Rotating assist rails/bars must be mounted in the specified positions and orientations shown in this owner's manual. Failure to comply with these instructions will cause serious injury.

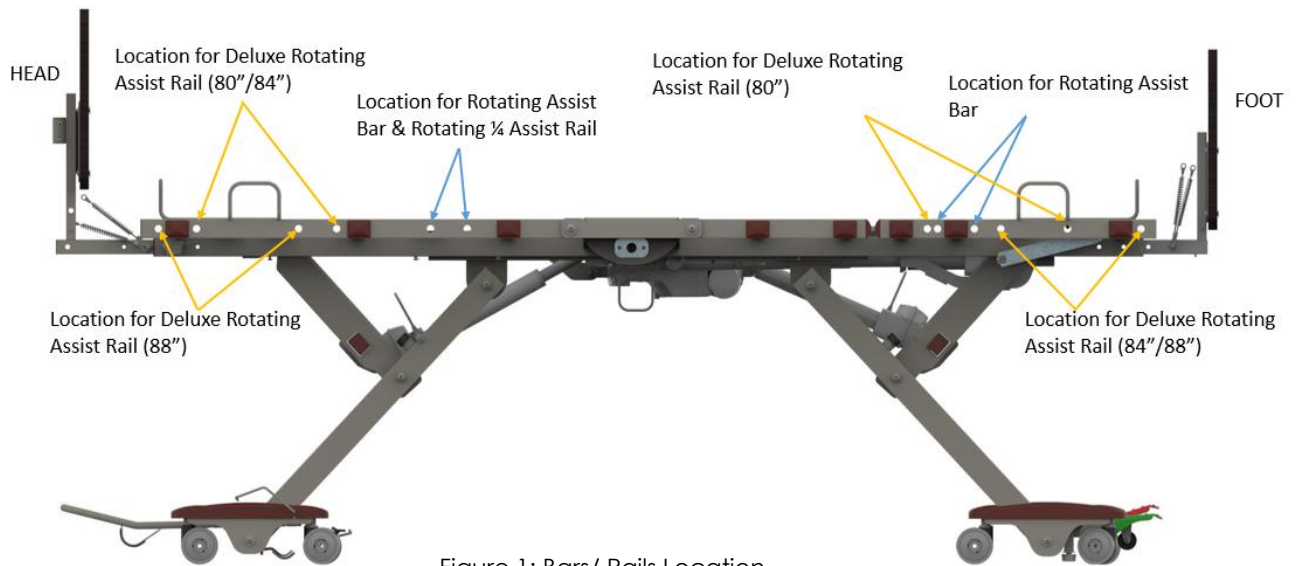

Figure 1: Bars/ Rails Location

DELUXE ROTATING ASSIST RAIL LOCATION



CAUTION

When the length of the sleep surface changed, the location of Deluxe Rotating Assist Rail must be changed along with the length of the sleep surface.

Option1: Mounting at the head deck only



Option 2: Mounting at the both head deck and foot deck



Option3: Conjunction with the rotating assist bar



ROTATING 1/4 ASSIST RAIL LOCATION



WARNING

When rotating 1/4 assist rails are unlocked they are free to rotate. Care must be taken to ensure the rotating 1/4 assist rail does not rotate toward the floor in an uncontrolled manner.

Option 1: Mounting at the head deck only	Option 2: Conjunction with the rotating assist bar

ROTATING ASSIST BAR LOCATION



WARNING

When rotating assist bars are unlocked they are free to rotate. Care must be taken to ensure the rotating assist bars does not rotate toward the floor in an uncontrolled manner.

Option 1: Mounting at the head deck only	Option 2: Mounting at the both head deck and foot deck

DELUXE ROTATING ASSIST RAIL INSTALLATION

1. Check the length of the sleep surface before mounting the deluxe rotating assist rail.
2. There are two washers on the bracket, take out one of the two washers

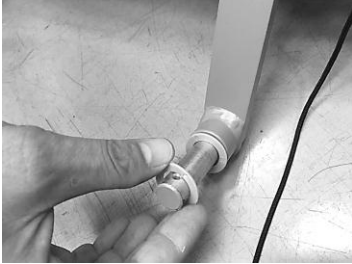

3. Choose appropriate location holes for mounting according to the actual size of the sleep surface. The mounting location is shown in the Figure 1 above.



4. Place the washer back to the mounting bracket, secure the rail by inserting the bowtie clips into the mounting bracket.



5. If you want to push down or raise the rail, press the pin to push down or raise



ROTATING 1/4 ASSIST RAIL INSTALLATION

Note: There is no need to adjust the location of rotating 1/4 assist rail, when the length of sleep surface changed.

1. Choose appropriate location holes for mounting. The mounting location is shown in the Figure 1 above.
2. Insert the mounting bracket of rotating 1/4 assist rail into the location holes.



3. Secure the rotating 1/4 assist rail by inserting the locking pin into the bed frame.



4. If you want to push down or raise the rail, press the pin to push down or raise



ROTATING ASSIST BAR INSTALLATION

Note: There is no need to adjust the location of rotating assist bar, when the length of sleep surface changed.

1. Choose appropriate location holes for mounting. The mounting location is shown in the Figure 1 above.
2. Insert the mounting bracket of rotating assist bar into the location holes.



3. Secure the rotating assist bar by inserting the locking pin into the bed frame.



4. If you want to push down or raise the rail, press the pin to push down or raise



STAFF CONTROL PANEL INSTALLTION AND ROUTING (OPTION)

TOOLS REQUIRED

• Pliers or Wire Cutters	• Philips Screwdriver
--------------------------	-----------------------

1. Raise the bed to the highest position. Unplug power cord from wall outlet
2. Place the staff control panel in the foot board, screw bolts to fix the panel

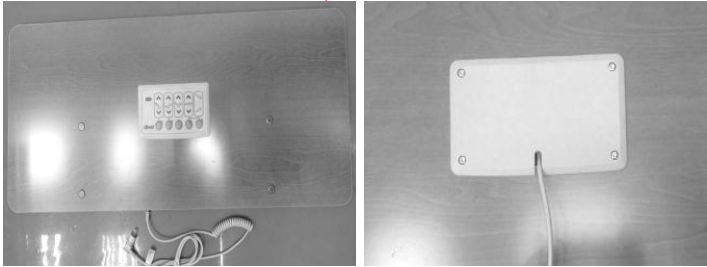

3. Lift the foot deck to the highest position.
4. Route the cable along with the foot actuator cable (black cable). Let the cable throughout the space between bed frame and seat deck. See the routing layout as below.

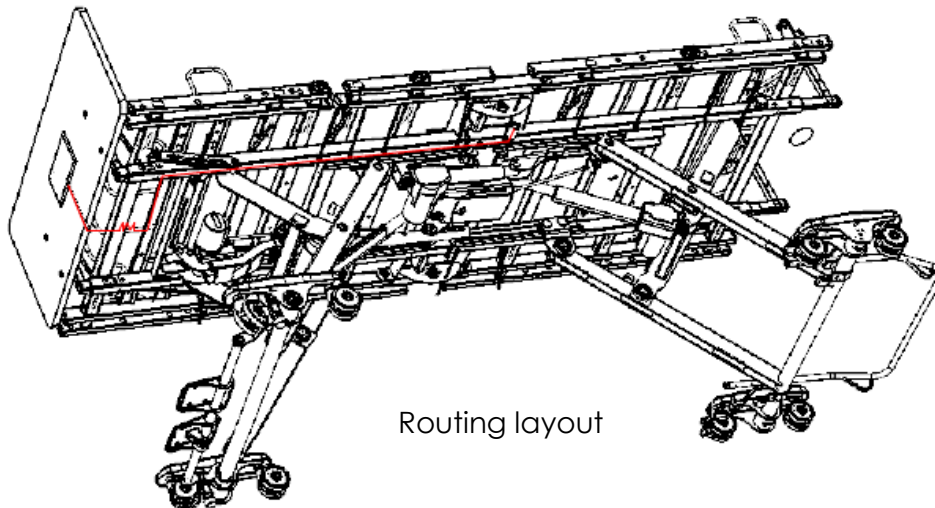

Routing layout

5. Secure the cable with zip ties.

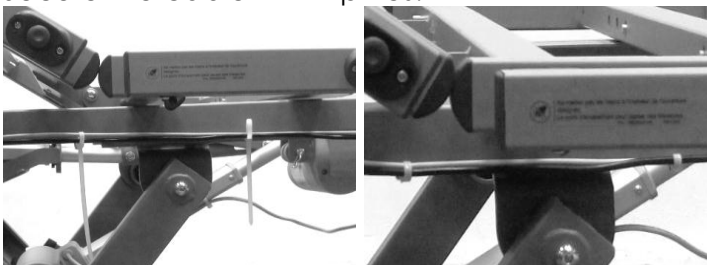

6. Plug the panel into the port of Y-cabel . Secure the plug by pressing the locking clip.

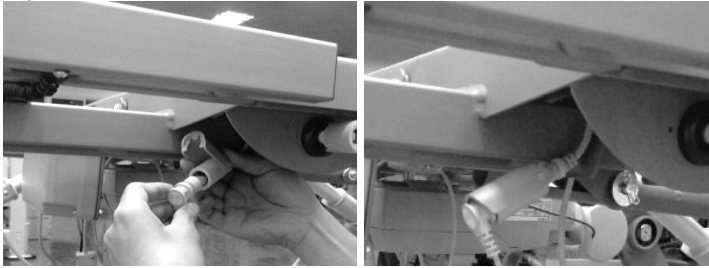

7. Lower the bed to the lowest position ensuring the moving parts will not pinch or shear the cable.

BATTERY BACK-UP (option)

TOOLS REQUIRED

<ul style="list-style-type: none"> • Philips screwdriver • 1/4" Allen wrench 	<ul style="list-style-type: none"> • #8 Wrench or socket
------------------------------------------------------------------------------------------------------	-------------------------------------------------------------------------

NOTE: Battery backup is for EMERGENCY purposes ONLY.

1. Mount the battery to the steel battery plate using the (4) #8 screws and nuts included.

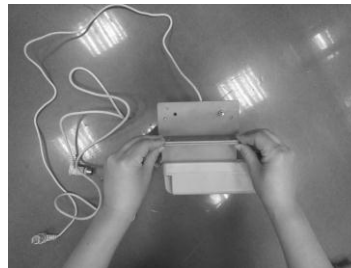
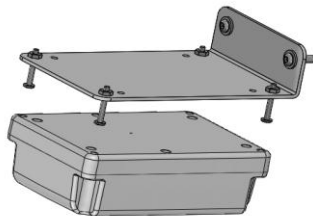

2. Remove the (2) 1/4" screws from central deck of the bed frame using 1/4" Allen wrench. Hold the mounting bracket of under bed light in place.



3. Mount the installed battery bracket to the mounting bracket of under bed light using (2) 1/4" screws which was removed in the last step.

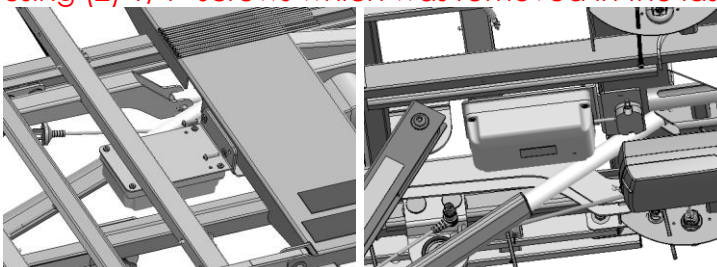

4. Remove the end cover by using screwdriver.

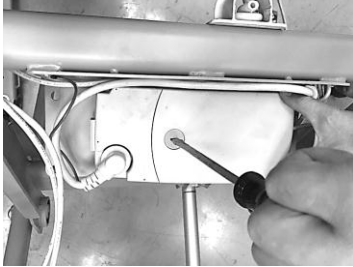

5. Insert the plug into the port CH5, Insert the end cover in place.

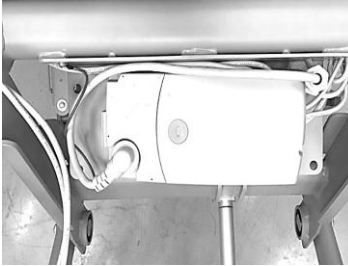
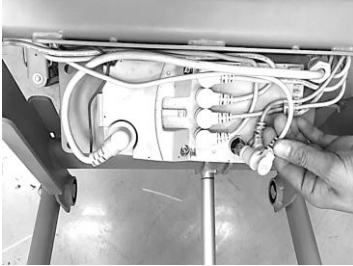

6. Tie the battery cable with a zip tie if the cable is too long

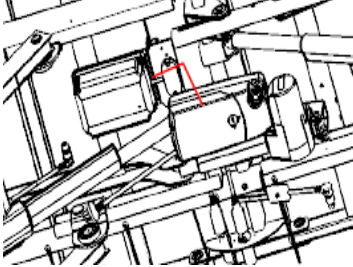

7. The battery back-up will now work if the bed becomes unplugged from the wall outlet or there is a power failure.

NOTE:

- Allow the battery to charge for a minimum of 24 hours before first use
- Battery back-up is specified as a part of bed
- Battery is not to be used in a damp environment such as outdoors

BATTERY BACK-UP INFORMATION



WARNING

- The battery backup should be used for EMERGENCY PURPOSES ONLY. The only compatible battery backup is a **Timotion TBB2 battery**.
- DO NOT use the battery backup to demonstrate or display a bed.
- If the battery backup is used, it MUST be recharged before becoming drained and dormant. If the battery is run dead and left for any extended period of time, the battery can go into HIBERNATION and cannot recover or be recharged.
- Battery function should be checked periodically to insure battery health. The battery should be removed, if leakage from battery.
- Drive DeVilbiss Healthcare cannot be held responsible for improper backup use.
- When a battery is connected to the control box, unplugging the bed from mains power will not switch bed off.
- The battery must be replaced by authorized service personnel ONLY.

**CAUTION**

- If improperly performed, equipment or property DAMAGE or resident INJURY is possible during maintenance.
- The battery is not a toy for children to play with.

Maintenance Notes:

- Following longer periods of storage, the battery may need to be charged and discharged several times so that performance reaches a peak.
- Batteries will lose their charge during storage. Battery should be fully charged prior to storing. A battery in storage should be recharged every 3 months at a minimum.

Care tips

- Make sure the battery is kept clean and dry at all times.
- The battery must receive sufficient ventilation when charging or discharging.
- Remove backup battery when bed is not likely to be used for some time.

Safety tips

- Don't open or damage the battery.
- Don't expose the battery to heat or open flames. Avoid storing it in direct sunlight.
- If the battery leaks and you come into contact with the fluid, wash the affected area thoroughly in water and consult a doctor immediately.
- Don't throw the battery into fire, open it, solder or weld to it.

Cleaning Notes

- Before cleaning, always unplug mains cable from wall outlet.
- When cleaning, take care not to damage the connection cable.
- Clean plastic surfaces such as the housing with slightly damp cloth. Never use cleaning agents on battery.
- Never use a high-pressure cleaner on the battery or spray fluids directly onto them using jets. You risk damaging the equipment.
- Solvents, alcohol, bleach, caustic agents, high acid or alkaline solutions or petroleum based products should not be used on the bed.

NOTE: *This bed NOT compatible with wash down tunnels.*

**WARNING**

Batteries must be disposed of in accordance with local regulations.

BED OPERATION



CRUSH HAZARD

Crush point exists due to LOW BED CLEARANCE. Do NOT place feet or other limbs under the frame when lowering the bed. When lowering the bed, be aware this may cause INJURY if limbs or personal items interfere with bed movement. Stay clear of the frame and ensure children and/or pets are not under the bed before lowering the bed.



WARNING

- It is critically important to lock all casters and brake system to prevent unintended bed movement.
- Possible injury or Death may occur due to pendant cord being a source for entangling patient/resident. Patients/residents with decreased mental acuity should NOT have access to pendant.

Initial Start Up (Bed Synchronization)

- After position bed, always lock all casters and brake system. Bed should be allowed to reach room temperature before plugging power cord into outlet.
- Lower the bed to near the lowest position.
- Hold down both bed frame height adjustment buttons simultaneously. This will cause the bed frame to lower to its lowest position. Once the bed frame stops moving, continue to hold the two buttons down for approximately 10 seconds.
- The bed is now synchronized. Operate bed as normal.

Pendant Operation

- The PrimeCare P903 bed comes standard with pendant control. Resident/patient and staff can use the pendant to adjust all mattress support platform sections to desired positions.

- 1. Push button to raise back
- 2. Push button to lower back
- 3. Push button to raise knee
- 4. Push button to lower knee
- 5. Push button to raise back and knee simultaneously (Auto Contour)
- 6. Push button to lower back and knee simultaneously (Auto Contour)
- 7. Push button to raise bed
- 8. Push button to lower bed
- 9. Push button to switch on and off the under bed light.
- 10. Push button for Cardiac Chair Position.
- To return the bed from the Cardiac Chair Position to horizontal position, press button #6 and/or #7 or #8

NOTE: For every 2 minutes of continuous actuator use, the bed actuators must not be used for 18 minutes.

Staff Control Panel Operation (optional)

The staff control panel allows caregiver to operate bed from the foot panel without walking to bedside. The caregiver can also individually lock out all functions on both pendant and staff control

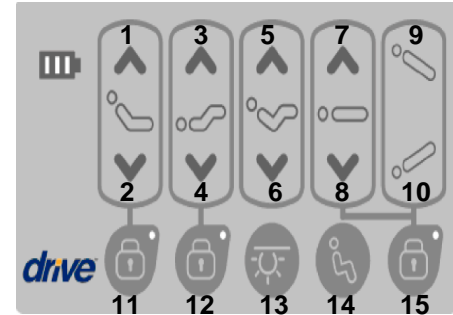

1. Push button to raise back;
2. Push button to lower back;
3. Push button to raise knee;
4. Push button to lower knee;
5. Push button to raise back and knee simultaneously (Auto Contour);
6. Push button to lower back and knee simultaneously (Auto Contour);
7. Push button to raise bed;
8. Push button to lower bed;
9. Push button for Trendelenburg
10. Push button for Reverse Trendelenburg;
11. Push button to change lockout status for raising & lowering back function and auto-contour function;
12. Push button to change lockout status for raising & lowering knee function and auto-contour function;
13. Push button to switch on and off the under bed light.
14. Push button for Cardiac Chair Position.
 - To return the bed from the Cardiac Chair Position to horizontal position, press button #6 and/or #7 or #8
 - The cardiac chair function will not work if any of other functions is locked.
15. Push button to change lockout status for Hi-lo movement and Trendelenburg & Reverse Trendelenburg function.

NOTE: For every two minutes of continuous actuator use, the bed actuators must not be used for 18 minutes.



CAUTION

- The use of Trendelenburg and Reverse Trendelenburg functions may not be suitable for certain patients/residents. This function should only be used with the recommendation and supervision of medical personnel.
- To avoid damage to the wall, the head end of the bed should be moved away from the wall when using the Trendelenburg function.



CRUSH HAZARD

- To eliminate any potential crush hazard, the Trendelenburg and Reverse Trendelenburg functions should be used only when the bed is at or near its highest position. This bed is capable of an angle greater than 12° for Trendelenburg and Reverse Trendelenburg positions. A crush hazard exists at the ends of the bed if the bed angle is the maximum it can reach. DO NOT allow bed to go to an angle greater than 14°.

PENDANT LOCATION



DANGER SHOCK HAZARD

Prior to working with any electrical parts, such as when plugging in the hand pendant, make sure power to the bed frame is disconnected by removing mains cable from wall outlet.

1. Plug the pendant into the end of the Y-cable located on the side of the bed you want the pendant to be attached. This requires proper alignment of the pendant cable and the Y-cable.
2. Plug the pendant into the port of Y-cabel. Sercure the pendant by pressing the locking clip.



3. Plug mains cable back into the wall outlet. Test all functions



WARNING

When routing cables in the medical bed, precautions shall be taken to avoid squeezing between parts of the medical bed.

HEEL LIFT RATCHET ADJUSTMENT

1. With the thigh deck section set at the preferred position, lift the foot deck.

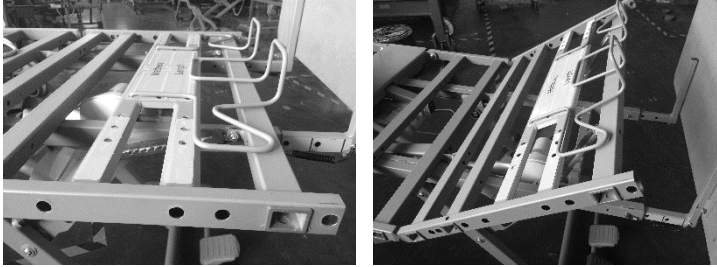

2. The manual foot lift section must be raised slowly to properly engage each stop at the desired height. The foot lift section will not lower past the nearest engaged stop.
3. To reset the ratchet mechanism and lower the manual foot lift section to its lowest position, raise the manual foot lift section to the highest setting and lower it in one motion to the flat position.
4. The foot section of the bed deck cannot be fully lowered without first manually adjusting the foot lift section to its lowest position.
5. Once in its lowest position, the manual foot lift can once again be raised to the desired height.

POWER CORD STORAGE

1. A Power cord strain relief located under the bed frame at the head end of the bed keeps the power cord off the floor and protects the power cord from getting severed or run over.
2. Disconnect the mains cable (power cord) from the wall outlet and store the power cord when the bed is not in use. Make sure the power cord is secured on the sleep deck and not hanging off the bed where it may be damaged. Secure the power cord to the head end of the bed when moving the bed.

BED MOBILIZATION AND STABILIZATION



WARNING

Unintended bed movement may occur if the floor lock or caster locks are left unlocked. Unintended bed movement may lead to property DAMAGE or resident INJURY. Never leave a bed unattended while the floor lock is not engaged.

FLOOR LOCK OPERATION

1. Press the red pedal down once with your foot to engage floor lock.

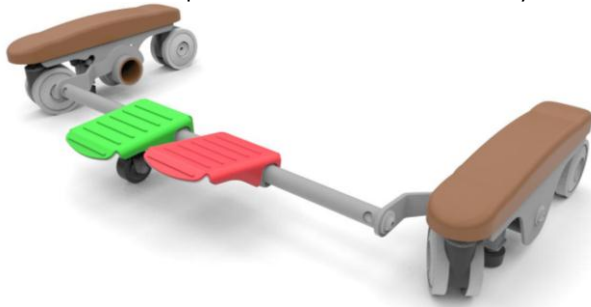

2. Press the green pedal down once with your foot to disengage the floor locks.
3. When the floor lock is disengaged the bed will be able move.

NOTE: Head end caster locks and caster bales must be disengaged for the bed to be moved freely in all directions.

CASTER LOCK

1. To lock the head of the bed use the two locking casters at the head end of the bed.
2. To lock the casters push down on the caster locking tabs on the top of the caster, this will help prevent the head end of the bed from moving.



3. To unlock the casters lift up on the caster locking tab on top of the caster, this will allow the bed to move in all directions.



CAUTION

Moving the bed while the floor lock or caster lock is engaged may cause DAMAGE to the bed or floor. Do not move the bed unless the floor lock and caster lock are unlocked.

Head End Caster Steer Alignment Mechanism (caster bale)

1. Caster Steer Alignment mechanism (caster bale) is on either side of the head end caster truck.
2. Align caster with the truck body and lower the bale over the caster.

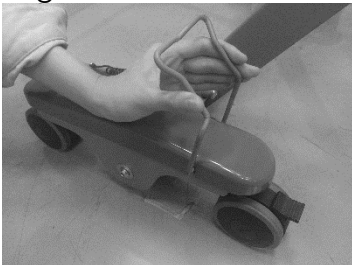

3. With the bale in place, the head end of the bed will tend to track in a straight line.
4. When used in conjunction with engaged Floor Lock system, Bale will help prevent side to side bed movement and should be in the lowered position at all times except when bed is being moved sideways by staff member.

CARE AND MAINTENANCE



CAUTION

If improperly performed, equipment or property DAMAGE or resident INJURY is possible during maintenance.

NOTICE TO MAINTENANCE STAFF

- Carry out all adjustment and cleaning procedures specified.
- Assembly of this bed and modifications made during the actual service life require evaluation to the requirements of IEC 60601-1 and IEC 60601-2-52.
- Before using, always check function of the bed and all accessories.
- Contact Drive DeVilbiss Healthcare if you need any help with installation, usage or maintenance of the product.

Corporate Office: Drive DeVilbiss Healthcare, 99 Seaview Blvd.,
Port Washington, NY 11050. Phone: 1-877-224-0946 Fax: 516-988-4601

Website: www.drivemedical.com

Manufacturer: Xiamen World Gear Sports Goods Co., Ltd.

Cleaning Instructions

- If possible, remove resident before cleaning bed.
- Prior to cleaning unplug power supply cords
- Ensure all electrical parts (motors, control boxes, wires and pendant) are not broken. Ensure that NO liquids enter electrical components.
- Remove all gross/solid contaminants, then wash and sanitize all components. DO NOT submerge the bed frame or electrical components.
- Solvents, alcohol, bleach, caustic agents, high acid or alkaline solutions or petroleum based products should not be used on the bed.
- Use standard water pressure. DO NOT power wash or steam clean any parts.
- Rinse completely with water (Maximum temperature 110°F or 43°C). Do not rinse with cold water.
- Ensure all parts are dry before using or storing.

NOTE: *This bed is NOT compatible with wash down tunnels.*

INSPECTIONS



WARNING

Failure to properly maintain your bed may decrease the life expectancy of your product, increase product maintenance requirements and costs and increase risk to residents and staff. **Always service the bed at the required intervals.**

INITIAL INSPECTION

- Inspection of All Components - Receipt of assembled bed
- Check bed components for obvious damage
- Inspect power supply cords for cuts and/or damage
- Check that actuator cords are connected properly to the controller
- Verify proper functionality of all features

QUARTERLY INSPECTION

- Inspect all welds for cracks.
- Check for bed noise and lubricate if appropriate.
- Check bed for proper function
- Inspect all fasteners for looseness, wear or damage. Replace or tighten as necessary.
- Ensure cables routed in the medical bed, will not be squeezed between parts of the medical bed.
- Check all electrical cable strain reliefs to ensure there are no cracks or breaks.
- If the bed has a battery backup, unplug power cord from the wall outlet and validate function. The battery may be built-in or portable.
- Inspect bed and Rotating Assist Bars/Rails bolts, if loose tighten and if missing replace.

Control Box

- Check power cord for chafing, cuts or wear.
- Ensure all attachment hardware and brackets are tight.
- Check electrical connections for wear or fractures.
- Verify that all actuator connections are tight.
- Ensure all electrical connections are fully engaged.

Pendant

- Check pendant cord for chafing, cuts or wear.
- Check all pendant buttons for proper function.

Actuators

- Check to make sure actuators do not bind at any point throughout their full range of motion.
- Check to ensure sleep surface is horizontal and actuators are synchronized properly.

Authorized Accessories

- Inspect all fasteners for looseness and wear. Replace or tighten as necessary.
- Ensure welds do not have cracks and visually inspect for stress
- Ensure no tubes are bent.
- If the bed has a battery, unplug bed from wall outlet and check for proper function.
- Check staff control panel for proper function.
- Ensure proper function of all accessories.

SEMI-ANNUAL INSPECTION

- Perform all Quarterly inspections.
- Check bed floor lock mechanism for proper function.

Control Box

- Check electrical wires for chafing, cuts, or wear.
- Check electrical connections for wear or fractures.

Actuators

- Check actuator cords for chafing, cuts or wear.
- Inspect push tubes and end connections of all actuators for excess wear or bending.
- Verify that all clevis pins are in place and are retained by bowtie clips.

Authorized Accessories

- Ensure proper function of accessory.
- Ensure no tubes are bent.

ANNUAL INSPECTION

- Perform all Quarterly and Semi-Annual inspections.

Actuators

- Inspect push tubes and end connections of all actuators for excess wear or bending.
- Verify that all clevis pins are in place and are retained by bowtie clips.

Casters

- Check that locks on casters lock properly (if equipped).
- Check that all casters roll properly.
- Check Floor Brake mechanism for proper function (roll at any height model).
- Check head end caster alignment (Bale) mechanism to verify proper function (roll at any height model).

SERVICING



DANGER SHOCK HAZARD

Possible Shock Hazard may occur if the main power supply cord for the Control Box is not unplugged from the wall outlet before any maintenance is performed on electrical components.

ACTUATORS WIRING



- CH1: Hi-Lo Actuator (Head)
- CH2: Hi-Lo Actuator (Foot)
- CH3: Foot Actuator
- CH4: Head Actuator
- CH5: Battery Back-Up
- CH6: Y-Cable/Pendant
- CH7: Y-Cable/Staff control panel /Under bed light

Replacing Control Box

- Unplug mains cable from the wall outlet
- Unplug connections for all actuators and accessories
- Separate the control box from the actuator
- Reinstall the control box on the actuator
- Plug all connections back into control box
- Plug mains cable into wall outlet
- Test function



WARNING

When routing cables in the medical bed, precautions shall be taken to avoid squeezing between parts of the medical bed.

Replacing Actuators

- Unplug mains cable from the wall outlet
- Identify the actuator to replace
- With the help of a second person place bed on its side to remove the actuators
- Unplug actuator cord from control box
- Actuator is held in place by (2) clevis pins
- Remove bowtie clips from clevis pins
- Slide the clevis pins out of the holes
- Replace the actuator
- To reassemble bed, reverse previous steps, and make sure to:
 - Assemble clevis pins as originally installed with bowtie clips
 - Zip ties should be replaced, with cords in their original position and routing direction to the control box
- Plug mains cable into wall outlet
- Test function



DANGER

Failure to replace bowtie clips on clevis pins at each end of actuator can result in harm to the user, operator and/or equipment.



WARNING

When routing cables in the medical bed, precautions shall be taken to avoid squeezing between parts of the medical bed.

Replacing the AC Power Cord (mains cable)

- Unplug mains cable from wall outlet
- Unplug the mains cable from the control box
- Remove tie-wraps holding power cord in place on frame
- Plug the new power cord into the control box
- Route the new power cord in the same manner as the original cord ensuring use of strain relief device at head end of bed
- Replace tie-wraps to hold power cord to frame
- Plug mains cable into wall outlet
- Test function



WARNING

When routing cables in the medical bed, precautions shall be taken to avoid squeezing those between parts of the medical bed.

TROUBLESHOOTING GUIDE



WARNING

Before doing any repairs or maintenance to the bed frame, read all instructions, cautions, and warnings. Repairs should be done by a skilled technician.

Problem	Solution
<p>If bed movement does not occur when pendant or staff control button is pushed.</p>	<ol style="list-style-type: none"> 1. Function may be locked. Check staff control panel function lockout. 2. Adjustment may already be at maximum or minimum level. 3. Bed is not plugged into wall outlet and battery has discharged. Plug bed into wall outlet. 4. Pendant cord may be damaged. Check cord for damage. If cord is damaged, discontinue bed usage until cord is replaced. 5. Pendant connection may be loose or damaged. Reconnect the pendant follow the steps in" Pendant Location" instruction on page 39.
<p>If adjustment only partially occurs and stops</p>	<ol style="list-style-type: none"> 1. Battery may be low. Plug bed into appropriate power source. 2. Bed may be overload or constrained from moving. Determine load and check for obstructions. 3. Actuators connection may be loose or damaged. Unplug the bed, and reconnect actuators follow the steps in "actuators wiring" instruction on page 46. 4. Thermal shut down. Wait a period of time before using the bed frame again. DO NOT keep trying to override this as it will shorten the life of your product. Bed is intended to be used for 2 min then allowed to rest for 18 min. 5. If problem persist, contact Drive DeVilbiss Healthcare 1-877-224-0946.
<p>Bed not responding to staff control</p>	<ol style="list-style-type: none"> 1. Check lockout status. 2. Check connection is fully inserted with cable secured. 3. Check the bed is plugged into appropriate power source. 4. Unplug bed for 60 seconds and plug back in. 5. Thermal shut down. Wait a period of time before using the bed frame again. DO NOT keep trying to override this as it will shorten the life of your product. Bed is intended to be used for 2 min then allowed to rest for 18 min. 6. If these steps fail to resolve the problem, contact Drive DeVilbiss Healthcare 1-877-224-0946

<p>Bed movement with brake system engaged and casters locked.</p>	<ol style="list-style-type: none"> 1. There may be an object in-between the floor and casters, the floor may be slippery. Clean the floor; remove any objects that may be in the way. Make sure the floor is dry. 2. Brake system may be malfunction, contact Drive DeVilbiss Healthcare 1-877-224-0946
<p>Bed does not stay level, Hi-lo actuators are no longer synchronized.</p>	<ol style="list-style-type: none"> 1. Hold the "Down" button until the bed reaches the lowest position and the LED flashes 3 times on the pendant. 2. If problem persist, contact Drive DeVilbiss Healthcare 1-877-224-0946.
<p>Bed is only moving straight forward not side to side</p>	<p>Caster alignment mechanism (Bale) is down. Lift caster alignment mechanism (Bale) up and bed will move in desired direction.</p>
<p>Bed is moving side to side</p>	<p>Caster alignment mechanism (Bale) is up. Push caster alignment mechanism(Bale) down and bed will move straight.</p>

WARRANTY

PrimeCare P903 Long Term Care Beds are guaranteed for a 3 year period from the date of production. This guarantee is against defects in materials and craftsmanship, under normal use and service.

This 3-year warranty includes electrical and mechanical parts and components. Bed mounted accessories and Head/Foot boards are covered for 1 year. Welds are covered under a limited lifetime¹ warranty of the product. Steel structural components are covered under the 15-year warranty from the date of delivery. During the warranty period, defective items will be repaired or replaced at Drive DeVilbiss Healthcare's option at no charge.

- ✓ Limited Lifetime warranty on welds. (1 Weld lifetime defined as 20 years from date of delivery)
 - ✓ 15 year warranty on structural steel frame.
 - ✓ 3 year warranty on electrical and mechanical parts and components.
 - ✓ 1 year warranty on all other parts and components.
- The PrimeCareP903 bed should only be used for its intended purpose and must be maintained and serviced in accordance with the instructions contained in this Owner's Manual.
 - This warranty will not apply if damage or mechanical failure is caused by abuse, improper assembly/use/cleaning/repair, accident, negligence, unauthorized alteration, or use in inappropriate environmental conditions, or failure to maintain the product consistent with user and service instructions.
 - Any change, adjustments, or repair not performed by a Drive DeVilbiss Healthcare Authorized Distributor or technician, will void the warranty.
 - This warranty is extended only to the original owner who purchased this product new and unused from Drive DeVilbiss Healthcare or a Drive DeVilbiss Healthcare

Authorized dealer/Distributor. Warranty is not extended and is not transferable or assignable to any subsequent purchaser or future owners.

- Drive DeVilbiss Healthcare's liability shall not exceed the original purchase price of this product.
- Any Repair work or replacement components provided shall not extend the warranty beyond the original warranty period.
- Request for Warranty coverage must be accompanied by valid serial number from the bed. Coverage is void if serial number has been removed, defaced, or altered.

Parts

Drive DeVilbiss Healthcare beds contain a variety of parts that wear from normal use. Some products are not covered under the 3-year warranty but do fall under the 90 day warranty, such as DC batteries. Drive DeVilbiss Healthcare's responsibility under this warranty is limited to supplying replacement parts, servicing or replacing, at its option, which are found to be faulty by Drive DeVilbiss Healthcare.

Warranty replacement parts are covered by the warranty until the product's 3- year warranty period expires. For warranty replacement, Drive DeVilbiss Healthcare requests that broken parts be sent back to them for evaluation. A credit will be issued only after the inspection and determination of cause.

Service

A majority of service requests can be handled by the facility maintenance department with assistance from Drive DeVilbiss Healthcare tech support. If a Drive DeVilbiss Healthcare technician is required, one will be provided by Drive DeVilbiss Healthcare at our discretion.

Most parts can be shipped next day air at the customer's expense.

This warranty is extended to the original purchaser of the equipment.

Sales and Service

Contact Drive DeVilbiss Healthcare if you need any help with installation, usage or maintenance of the product.

Corporate Office: Drive DeVilbiss Healthcare, 99 Seaview Blvd., Port Washington, NY 11050

Phone: 1-877-224-0946 Fax: 516-988-4601

Website: www.drivemedical.com

Manufacturer: Xiamen World Gear Sports Goods Co., Ltd.

END OF LIFE DISPOSAL

- Many components of this product may be recycled.
- Please dispose of non-recyclable items properly.

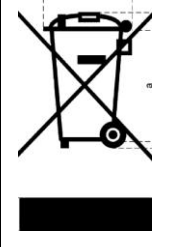
	<p>This marking indicates that this product should not be disposed with other household wastes throughout the EU. To prevent possible harm to the environment or human health from uncontrolled waste disposal, recycle it responsibly to promote the sustainable reuse of material resources. To return your used device, please use the return and collection systems or contact the retailer where the product was purchased. They can take this product for environmental safe recycling.</p>
-----------------------------------------------------------------------------------	---------------------------------------------------------------------------------------------------------------------------------------------------------------------------------------------------------------------------------------------------------------------------------------------------------------------------------------------------------------------------------------------------------------------------------------------------------------------------------------------------

NOTE: *The information within this document is subject to change without notice. This manual includes important information about safety of personnel and equipment. As you read through this manual be aware of the four signal indicators.*

APPENDIX

SPECIAL NOTE

For your convenience, we have provided the April 2010 edition of the FDA's guide to bed safety. This information from the FDA's brochure, published by Hospital Bed Safety Workgroup, is replicated verbatim; the latest version is available at <http://www.fda.gov>.

A Guide to Bed Safety Bed Rails in Hospitals, Nursing Homes and Home Health Care: The Facts

Bed Rail Entrapment Statistics

Today there are about 2.5 million hospital and nursing home beds in use in the United States. Between 1985 and January 1, 2009, 803 incidents of patients* caught, trapped, entangled, or strangled in beds with rails were reported to the U.S. Food and Drug Administration. Of these reports, 480 people died, 138 had a nonfatal injury, and 185 were not injured because staff intervened. Most patients were frail, elderly or confused.

** In this brochure, the term patient refers to a resident of a nursing home, any individual receiving services in a home care setting, or patients in hospitals.*

Patient Safety

Patients who have problems with memory, sleeping, incontinence, pain, uncontrolled body movement, or who get out of bed and walk unsafely without assistance, must be carefully assessed for the best ways to keep them from harm, such as falling.

Assessment by the patient's health care team will help to determine how best to keep the patient safe. Historically, physical restraints (such as vests, ankle or wrist restraints) were used to try to keep patients safe in health care facilities. In recent years, the health care community has recognized that physically restraining patients can be dangerous. Although not indicated for this use, bed rails are sometimes used as restraints. Regulatory agencies, health care organizations, product manufacturers and

advocacy groups encourage hospitals, nursing homes and home care providers to assess patients' needs and to provide safe care without restraints.

The Benefits and Risks of Bed Rails

Potential benefits of bed rails include:

- Aiding in turning and repositioning within the bed.
- Providing a hand-hold for getting into or out of bed.
- Providing a feeling of comfort and security.
- Reducing the risk of patients falling out of bed when being transported.
- Providing easy access to bed controls and personal care items.

Potential risks of bed rails may include:

- Strangling, suffocating, bodily injury or death when patients or part of their body are caught between rails or between the bed rails and mattress.
- More serious injuries from falls when patients climb over rails.
- Skin bruising, cuts, and scrapes.
- Inducing agitated behavior when bed rails are used as a restraint.
- Feeling isolated or unnecessarily restricted.
- Preventing patients, who are able to get out of bed, from performing routine activities such as going to the bathroom or retrieving something from a closet.

Meeting Patients' Needs for Safety

Most patients can be in bed safely without bed rails. Consider the following:

- Use beds that can be raised and lowered close to the floor to accommodate both patient and health care worker needs.
- Keep the bed in the lowest position with wheels locked.
- When the patient is at risk of falling out of bed, place mats next to the bed, as long as this does not create a greater risk of accident.
- Use transfer or mobility aids.
- Monitor patients frequently.
- Anticipate the reasons patients get out of bed such as hunger, thirst, going to the bathroom, restlessness and pain; meet these needs by offering food and fluids, scheduling ample toileting, and providing calming interventions and pain relief.

When bed rails are used, perform an on-going assessment of the patient's physical and mental status; closely monitor high-risk patients. Consider the following:

- Lower one or more sections of the bed rail, such as the foot rail.
- Use a proper size mattress or mattress with raised foam edges to prevent patients from being trapped between the mattress and rail.
- Reduce the gaps between the mattress and side rails.

Which Ways of Reducing Risks are Best?

A process that requires ongoing patient evaluation and monitoring will result in optimizing bed safety. Many patients go through a period of adjustment to become comfortable with new options. Patients and their families should talk to their health care planning team to find out which options are best for them.

Patient or Family Concerns About Bed Rail Use

If patients or family ask about using bed rails, health care providers should:

- Encourage patients or family to talk to their health care planning team to determine whether or not bed rails are indicated.
- Reassure patients and their families that in many cases the patient can sleep safely without bed rails.
- Reassess the need for using bed rails on a frequent, regular basis.

To report an adverse event or medical device problem, please call FDA's Med Watch Reporting Program at 1-800-FDA-1088.

For additional copies of this brochure, see the FDA's [Hospital Bed website](#).

For more information about this brochure, contact Beryl Goldman at 610-335-1280 or by e-mail at bgoldman@kendaloutreach.org. She has volunteered to answer questions.

For information regarding a specific hospital bed, contact the bed manufacturer directly.

Developed by the Hospital Bed Safety Workgroup

Participating Organizations:

- AARP
- ABA Tort and Insurance Practice Section
- American Association of Homes and Services for the Aging
- American Health Care Association
- American Medical Directors Association
- American Nurses Association
- American Society for Healthcare Engineering of the American Hospital Association
- American Society for Healthcare Risk Management
- Basic American Metal Products
- Beverly Enterprises, Inc.
- Care Providers of Minnesota
- Carroll Healthcare
- DePaul College of Law
- ECRI
- Evangelical Lutheran Good Samaritan Society
- Hill-Rom Co., Inc.
- Joerns Healthcare, Inc.
- Joint Commission on Accreditation of Healthcare Organizations
- Medical Devices Bureau, Health Canada
- National Association for Home Care
- National Citizens' Coalition for Nursing Home Reform
- National Patient Safety Foundation
- RN+ Systems
- Stryker Medical
- The Jewish Home and Hospital
- Untie the Elderly, The Kendal Corporation
- U.S. Food and Drug Administration



Drive DeVilbiss Healthcare, 99 Seaview Blvd., Port Washington, NY 11050

Phone: 1-877-224-0946 Fax: 516-988-4601

www.drivemedical.com